

XYZ Machine Tools Bed Mills ProtoTRAK® RMX CNC Safety, Programming, Operating and Care Manual

Part Number:	17701
Version:	180619

Covers Current Models:

**XYZ RMX 2500
XYZ RMX 3500
XYZ RMX 4000
XYZ RMX 5000**



XYZ Machine Tools Ltd.
Woodlands Business Park
Burlescombe, Tiverton, Devon EX16 7LL
T: 01823 674200 F: 01823 674201
www.xyzmachinetools.com

Copyright 2019, XYZ Machine Tools Ltd. All rights are reserved. No part of this publication may be reproduced, stored in a retrieval system, or transmitted, in any form or by any means, mechanical, photocopying, recording or otherwise, without the prior written permission of XYZ Machine Tools Ltd.

While every effort has been made to include all the information required for the purposes of this guide, XYZ Machine Tools Ltd. assumes no responsibility for inaccuracies or omission and accepts no liability for damages resulting from the use of the information contained in this guide.

All brand names and products are trademarks or registered trademarks of their respective holders.

XYZ Machine Tools Ltd
Woodlands Business Park
Burlescombe
Devon EX16 7LL
Phone 01823 674200 ▪ Fax 01823 674201
www.xyzmachinetools.com

Contents

1.0 Introduction	1
1.1 Using This Manual	1
2.0 Safety	2
2.1 Introduction	2
2.2 Safe Operating Information	2
2.3 Release of Trapped Persons	4
2.4 Danger, Warning, Caution, and Note Labels and Notices Used in this Manual	5
3.0 Description	11
3.1 ProtoTRAK RMX Control Specifications	11
3.1.1 List of System Specifications	11
3.2 ProtoTRAK RMX Options	17
3.2.1 Advanced Features	17
3.2.2 TRAKing® / Electronic Handwheels	17
3.2.3 DXF File Converter Option	17
3.2.4 Parasolid File Converter Option	17
3.2.5 Verify Option	18
3.3 Display Pendant	18
3.3.1 Front	18
3.3.2 Display Back	20
3.4 Machine Specifications	21
Model Name	24
3.5 Standard Equipment	25
3.6 Optional Equipment	25
3.6.1 Electronic Handwheels	25
3.6.2 Auxiliary Functions	25
3.6.5 Remote Stop Go Switch	25
3.5.10 30-Taper Spindle	25
3.6 Lubrication System	25
3.7 Electrical Cabinet	26
3.8 Integrated Head and Quill Encoders	26
3.9 Servo Motors	26
4.0 Basic Operation	27
4.1 Powering Up the System	27
4.2 Shutting down the ProtoTRAK RMX CNC	27
4.3 Operator Run Keys	28
4.3.1 Feed	28
4.3.2 Spindle Control	28
4.3.3 EHW Fine/Coarse	28
4.3.4 Accessory	28
4.3.5 Power / Reset	28
4.4 Manual Operation of the Head, Table and Saddle	28
4.5 Emergency Stop	29
4.6 Switching between Two and Three-axis Operation	29
4.7 Data Input Keys	29
4.8 Modes	29
4.9 Gestures	29
5.0 Definitions, Terms & Concepts	29
5.1 ProtoTRAK RMX CNC Axis Conventions	29
5.2 Part Geometry & Tool Path Programming	30

5.3 Planes and Vertical Planes	31
5.4 Absolute & Incremental Reference	31
5.5 Referenced & Non-Referenced Data	32
5.6 Incremental Reference Position in Programming	32
5.7 Tool Diameter Compensation	32
5.8 Tool Diameter Compensation when Contouring in Z with Part Geometry.....	33
5.9 Connective Events.....	34
5.10 Conrad	34
5.11 Memory & Storage	36
6.0 Info Keys	37
6.1 Status	38
6.1.1 Operational Status	38
6.1.2 Software Version	38
6.1.3 Options Activated.....	38
6.1.4 Features Off/On.....	38
6.2 Tool Table	39
6.2.1 The Base Tool	41
6.2.2 Setting Z Offsets.....	41
6.2.3 Using Library Tools while programming.....	42
6.2.4 Soft keys in the Tool Table	42
6.3 EPA.....	42
6.3.1 EPA Index	43
6.3.2 Searching the EPA Index	43
6.3.3 Navigating through a Topic	44
6.4 Math Help.....	44
6.4.1 Example – using Math Help 17.....	44
6.5 Defaults	47
6.5.1 Default entries and what they mean.	47
6.5.2 Working with Defaults.....	51
6.6 Options	56
6.7 Keyboard.....	58
6.8 Calculator	58
7.0 DRO Mode	59
7.1 DRO Functions.....	59
7.2 Apply Tool Library data to DRO operations (Advanced Features Option)	60
7.3 Spindle RPM	60
7.3.1 Setting Spindle Speed and Values	61
7.3.2 Overriding Spindle Speed	61
7.4 Feedrates in the DRO Mode.....	61
7.4.1 Setting Feedrate and Units	61
7.4.2 Overriding Feedrates.....	62
7.5 Power Feed	62
7.6 Go To (TRAKing/Electronic Handwheels Option).....	62
7.7 Return to Absolute Zero	62
7.8 Center.....	63
7.9 Jog	63
7.10 Teach.....	63
8.0 Program Mode Part 1: Getting Started and Some General Info	65
8.1 Programming Overview	65
8.2 Info Keys.....	65
8.3 Program Header (Event 0) Screen.....	65
8.4 Starting to Program.....	67
8.5 Part Drawing while Programming	67

8.6 Soft Keys within the Event.....	69
8.7 Z Rapid and Safety Plane.....	69
8.8 Editing Data while Programming	70
8.9 Finish Cuts	70
8.10 Programming in 2 vs 3 axis.....	70
8.11 Using multiple fixtures (Advanced Features Option).....	70
8.11.1 Fixtures and Running the Program	71
8.11.2 Editing Fixtures.....	71
9.0 Program Mode Part 2: Program Events.....	72
9.1 Prompts Found in Events.....	72
9.2 Event Types.....	74
9.2.1 POSN: Position Events.....	74
9.2.2 DRILL TAP Event	74
9.2.3 Bolt Hole	74
9.2.4 Mill	75
9.2.5 Arc.....	75
9.2.6 PROFILE Events.....	75
9.2.7 Face Mill.....	76
9.2.8 Pocket Events.....	76
9.2.9 Islands Events	76
9.2.10 Subroutine Events.....	77
9.2.11 Copy Events	79
9.2.12 Helix event	80
9.2.13 Engrave.....	81
9.2.14 Thread Mill Event.....	81
9.2.15 Aux Events	82
9.2.16 Pause.....	82
9.3 Finishing Teach Events.....	82
10.0 Program Mode Part 3: Irregular Profiles, Pockets and Islands	84
10.1 Starting the A.G.E.	84
10.2 Prompts in A.G.E. Mill programming:	85
10.3 Prompts in A.G.E. Arc programming:	85
10.4 Skipping over prompts.....	85
10.5 OK/NOT OK	85
10.6 Ending A.G.E.	85
10.7 Reopening A.G.E.	86
10.8 Guessing ends and centres	86
10.9 Calculated Data.....	87
10.10 Tangency.....	87
10.11 Line Angle.....	88
10.12 Chord Angle.....	89
10.13 Sample A.G.E. program	89
11.0 Edit Mode	97
11.1 Delete Events	97
11.2 Search Edit	97
11.2.1 Selecting Data to be Displayed on the Search Edit Table	98
11.2.2 Sorting Data	98
11.2.3 Making Changes to Data.....	98
11.3 Erase Program	101
11.4 G-Code Editor	101
11.5 Clipboard (Advanced Feature).....	101
12.0 Set-Up Mode.....	103
12.1 Tool Path.....	103

12.2	Reference Positions (REF POSN).....	104
12.2.1	Z Retract	104
12.2.2	Home Positions	104
12.2.3	Limit Positions	104
12.3	Fixture Offsets	105
12.4	Verify Part (Advanced Features Option)	105
12.5	Service Codes	106
12.5.1	Software	106
12.5.2	Machine Set-Up	106
12.5.3	Diagnostic Codes	107
12.5.4	Operator Defaults/Options	108
12.5.5	Lube Pump Codes	108
13.0	Run Mode	109
13.1	Run Mode Screen	109
13.2	Starting to Run.....	109
13.3	Program Run.....	110
13.4	TRAKing/ Electronic Handwheel Option.....	110
13.4.1	TRAKing in Two-Axis CNC.....	111
13.5	Program Run Messages	111
13.6	Stop	111
13.7	Chip Clear.....	111
13.8	Feedrate and Speed Overrides	111
14.0	Program In/Out	112
14.1	Getting to files and directories.	112
14.2	Saving a program.....	113
14.3	Opening a saved program.....	113
14.4	Temp files.	113
14.5	Deleting a program or folder.....	113
14.6	Renaming a program or folder.	114
14.7	Create a new folder.....	114
14.8	Copy or Cut a file or folder.....	114
14.9	Backing Up Programs	115
14.10	Look On.....	115
14.11	File extensions.	115
14.12	Supported G codes for CAM converter	116
14.13	Supported G codes for GCD programs	117
14.14	Networking	118
14.14.1	Networking – Windows 7	119
14.14.2	Networking – Windows 10	130

1.0 Introduction

We are delighted to introduce to you the ProtoTRAK RMX, the most advanced control ever made for toolroom and small production milling. The ProtoTRAK RMX represents our decades of deep involvement in the world of making parts in small quantities. It transforms the best of technology into the ultimate tool for the people who make things on the shop floor.

The **Touch Screen** Interface enables you to interact with your programs and set ups with more certainty and control than ever before. See Section 6.5.

Defaults allow you to customize the ProtoTRAK RMX for how *you* make parts; they are easy to set and easy to change. See Section 6.5.

The **large LCD screen** and **fly out windows** allow you work with everything you need at the same time without flipping between screens.

Enhanced ProtoTRAK Assistance (EPA) is always available for you to quickly look up the information you need for what you are doing at the time. See Section 6.3.

With a little practice, you will find that the ProtoTRAK RMX is the easiest to use, most powerful ProtoTRAK ever...and that is saying a lot!

Manual machining is always available and made easier with features like power feed, rapid positioning, tool offsets and all the best features of sophisticated DRO's.

Two-axis machining is available at the touch of a button for prototyping and moderately complex, low volume work.

Three-axis machining is programmed and run with unprecedented flexibility. Programs may be entered at the control or imported from CAD/CAM files. Advanced colour graphics show program features.

1.1 Using This Manual

This manual provides enough information for most users in most situations. If you ever need more information or clarification, we want to help.

- Call us at 01823 674200 and ask for Applications
- Visit our website: www.xyzmachinetools.com
- Talk to your local XYZ Machine Tools representative

Section 2 of this manual provides important safety information. It is essential that all operators of this product review this safety information.

Section 3 provides a description of the TRAK Bed Mill and the ProtoTRAK RMX CNC. Machine Control Options are described in this section.

Section 4 describes the operation of the milling machine and some basic operations of the ProtoTRAK RMX CNC.

Section 5 defines some terms and concepts useful in learning to program and operate the ProtoTRAK RMX CNC.

Section 6 describes the innovative Information Keys including Defaults, Options and EPA (Enhanced ProtoTRAK Assistance).

Section 7 describes the powerful capabilities in DRO mode that will make your manual work more productive than ever.

Section 8 Programming, Part 1: covers some general programming information and Instructions on starting new programs.

Section 9 Programming, Part 2: Program Events - instructions for the canned cycles, or events, used to program the ProtoTRAK RMX CNC.

Section 10 Programming, Part 3: the A.G.E., or Auto Geometry Engine, so powerful it gets its own section.

2.0 Safety

2.1 Introduction

Manual mills were traditionally used by skilled machinists. Prototrak was designed to replace these manual machines and at the same time enhance productivity by adding CNC control.

But, unlike Machining and Turning Centres that can be operated even with unskilled staff (in some modes), Prototrak is designed to be used exclusively by skilled or experienced machinists.

The safe operation of the RMX Mill and ProtoTRAK RMX CNC depends on its proper use and the precautions taken by the operators.

2.2 Safe Operating Information

This machine is designed for the milling of cold metal within the stated capacity of the mill with axes movement occurring by manual use of handwheels or CNC control.

This machine must not be used for machining flammable materials (e.g. magnesium) without undertaking a risk assessment and incorporating any additional safety measures identified.

It is designed to be used in a standard workshop environment only.

It is the responsibility of the employer, machine owner or machine controller to ensure that this machine is installed, operated and maintained in accordance with the Provision and Use of Work Equipment Regulations (1998) or equivalent local regulations.

In particular, the responsible person must:

- Undertake a Risk Assessment on the use of this machine, paying particular attention to the unique characteristics of the ProtoTrak control system (for example, operating mode selection and access to the work zone)
- Generate and apply Safe Operating Procedures for the use of the Prototrak machine
- Provide any additional training, safeguarding and PPE identified by the risk assessment.

All operators must read and study this ProtoTRAK RMX CNC Safety, Programming, Operating, and Care Manual. The machine must not be operated until operators understand the operation and safety requirements of this machine.

This machine must only be operated by trained and experienced operators. Any other users should first be subjected to a risk assessment by a responsible, trained person.

The following Safety Features must be checked on a regular basis (for example at the start of every shift):

1. E-stop – Press the E-stop button and ensure that the control flags up faults 261 (E-stop active) and 0055 (machine disabled) and that the axes and spindle cannot be started.
2. Guard Interlocks – Start the spindle at maximum speed and then open each door guard in turn. Check that the spindle stops quickly (around 1 second) and cannot be re-started and that the maximum feedrate is limited to 2m/min (78 ipm)
3. Safety Speed Monitoring – Close the table guards and whilst jogging at max feedrate, open the table guards. Check for a fault 247, 248 or 249, depending on which axes was jogging (max permissible feedrate exceeded).
4. Table Guards: Inspect the table guards for signs of damage (especially the transparent panels). Replace if any part of the guard is damaged. Replace the transparent panels in accordance with the stated schedule, regardless of their apparent condition (see the FAQ on our website for why this is important). Do not forget to use the retractable guard at the back of the table.

Notes on the E-stop and Guard critical safety functions:

- E-stop:
 - This is provided by a safety rated, hard-wired E-stop system controlled by the E-stop button on the pendant or table guard. When the machine is E-stopped, the axes are disabled and the spindle is put into a Safe Torque Off mode.
 - Releasing the E-stop button and pressing the Reset button, will always take the machine out of the hardware E-stop condition (unless there is a fault with the safety circuits). However, the machine may still be disabled because of the current machine mode, or on the results of software safety checks undertaken by the control (fault 0055). This an "NC Not ready" state; and should not be confused with the hardware E-stop condition.
 - If you wish to leave the machine in a hardware E-stop condition, for example, when leaving the machine unattended, always press in, and leave pressed in, one of the E-stop buttons. Do not twist to release the E-stop button until you are ready to make the machine live again.
- Door Guards:
 - When the door guards are opened, the spindle control system actively drives the spindle to a stop very quickly, but the spindle remains powered. After a short delay, the spindle is put into a Safe Torque Off mode, where the spindle is now completely safe. This time delay coincides with the spindle air brake being applied.
 - Therefore, DO NOT touch the spindle until the spindle is in the Safe Torque Off Mode, i.e. the air brake has engaged (which occurs approximately 3 seconds after the door guards are opened).
 - Note, if the table guards are closed again at about the same time as the delay expires, due to small differences in each of the dual channel safety circuits, it is possible for the safety circuit to lock out and then the spindle cannot be run. In this case, simply open the guards again and wait about 5 seconds before closing.

When operating this machine, always observe the following safety precautions

- Do not operate this machine without knowing the function of every control key, button, knob, or handle.
- Always wear the appropriate personal protective equipment, including safety glasses and safety shoes.
- Do not wear loose fitting gloves whilst operating this machine as they could easily get caught in moving parts.
- Never wear rings, watches, long sleeves, neckties, jewelry, or other loose items when operating the machine.
- Keep your hair away from moving parts. Wear adequate safety head gear.
- Never operate any machine tool after consuming alcoholic beverages, or taking strong medications, or while using non-prescription drugs.
- Carry out a COSHH risk assessment and use the correct protection equipment, e.g. barrier cream/latex gloves, to prevent harm from items such as cutting fluid, lubrication oil and other substances used on the machine.
- Do not use compressed air to remove swarf or clean the machine. This can damage the slideway seals and create coolant mist which can be harmful. XYZ recommend the use of BioConcept cutting fluids which do not present a risk to the respiratory tract.
- Always ensure the appropriate guarding is in place for the machinery operation being undertaken. Never reach around a guard to gain access to the part, tool, or fixture.
- Do not raise the cutting tool above the table guards without additional guarding measures such as a cutter guard.
- Observe and understand the warning and safety information labels affixed to this machine.
- Do not attempt to tamper with or override any guarding/safety device fitted to the machine.

- Keep the working area clear and remove all tools (spanners etc.) from the machine before you start the machine running. Loose items can become dangerous flying projectiles.
- Stop the machine spindle, open the table guards and take the CNC control out of an active mode (DRO, RUN, TOOL SETUP):
 - Before changing tools.
 - Before changing parts.
 - Before you clear away the Swarf, oil or coolant. Always use a chip scraper or brush.
 - Before you make an adjustment to the part, vice, coolant nozzle or take measurements.
- Keep work area well lit. Ask for additional light if needed.
- Be aware that the machine can move unexpectedly so do not lean on the machine while it is running.
- To prevent slippage and personal injury, keep the working area around the machine dry and clean. Ensure there is no swarf, oil, coolant and obstacles of any kind around the machine.
- Avoid getting pinched in places where the spindle, table or guard doors create "pinch points" whilst the machine is in motion.
- For machines fitted with manual handwheels: to prevent injury during powered axes movement, keep the handle folded inside the hand wheel at all times except when required to hand crank the table.
- Securely clamp and properly locate the workpiece in the vice or in a fixture. Use proper tool holding equipment.
- Use the correct tooling for the process being undertaken. Never use damaged or worn tools and ensure the correct cutting parameters (speed, feed, and depth of cut) are used in order to prevent tool breakage.
- Prevent damage to the workpiece or the cutting tool. Never start the machine (including the rotation of the spindle) if the tool is in contact with the part.
- Avoid large overhangs on cutting tools when not necessary.
- To prevent fires, keep flammable materials and fluids away from the machine, hot swarf and workpieces.
- Never change gears when the spindle is rotating
- Do not rotate the spindle by hand unless the table guard is open.
- Stop and disconnect the power to the machine before undertaking any machine cleaning or maintenance

2.3 Release of Trapped Persons.

In the event of persons being trapped in the machine:

1. Hit the E-button to kill all power to the spindle and axes.
2. Open the table guards.
3. If trapped by spindle or tool, remove the compressed air supply to the machine and rotate the spindle by hand to free the trapped person.
4. If trapped by the axes, use the manual handwheels to move the axes slowly clear of the trapped person.
5. If no manual handwheels are fitted, remove the relevant axes drive cover and wind the ballscrew by hand to clear the trapped persons. Alternatively, reset the E-stop (but leave the table guards open) and put the control into DRO mode. Select Fine (feed rate) on the control and use the Electronic Handwheels to move the axes slowly clear of the trapped person.

2.4 Danger, Warning, Caution, and Note Labels and Notices Used in this Manual

DANGER - Immediate hazards that *will* result in severe personal injury or death. Danger labels on the machine are red in color.

WARNING - Hazards or unsafe practices that *could* result in severe personal injury and/or damage to the equipment. Warning labels on the machine are amber in color.

CAUTION - Hazards or unsafe practices that *could* result in minor personal injury or equipment/product damage. Caution labels on the machine are Yellow in color.

NOTE - Call attention to specific issues requiring special attention or understanding.

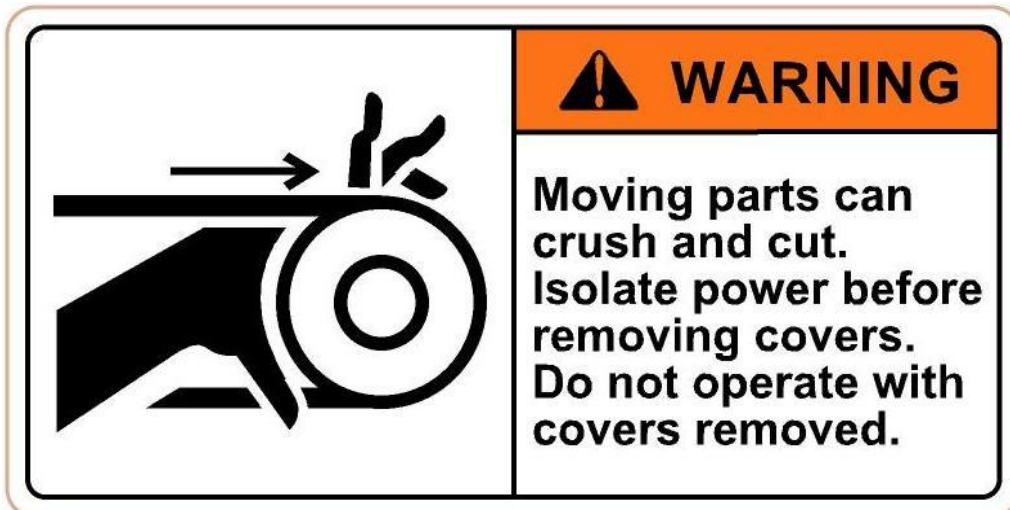

Safety & Information Labels Used on RMX Bed Mills

It is forbidden by law to deface, destroy or remove any of these labels

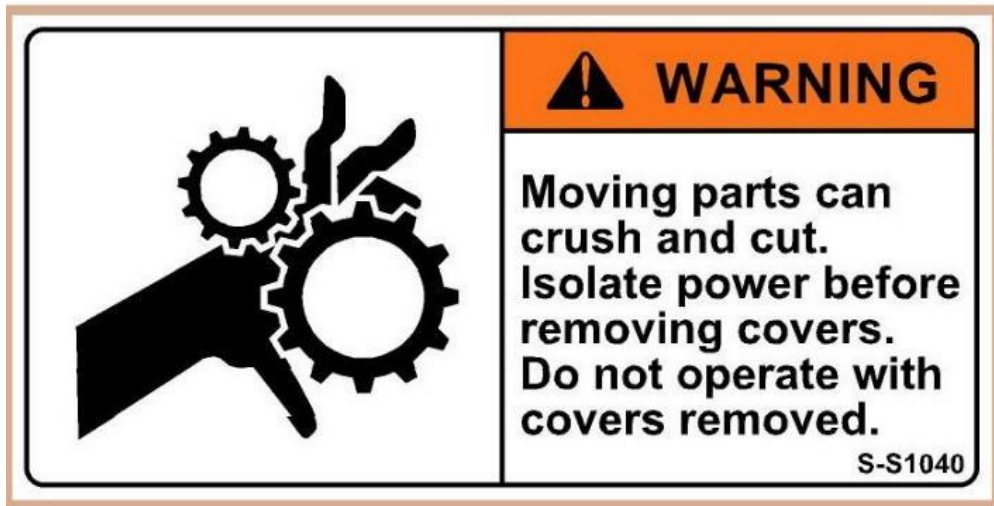

Safety & Information Labels Used on RMX Bed Mills

It is forbidden by law to deface, destroy or remove any of these labels



Safety & Information Labels Used on RMX Bed Mills

It is forbidden by law to deface, destroy or remove any of these labels



Safety & Information Labels Used on RMX Bed Mills

It is forbidden by law to deface, destroy or remove any of these labels

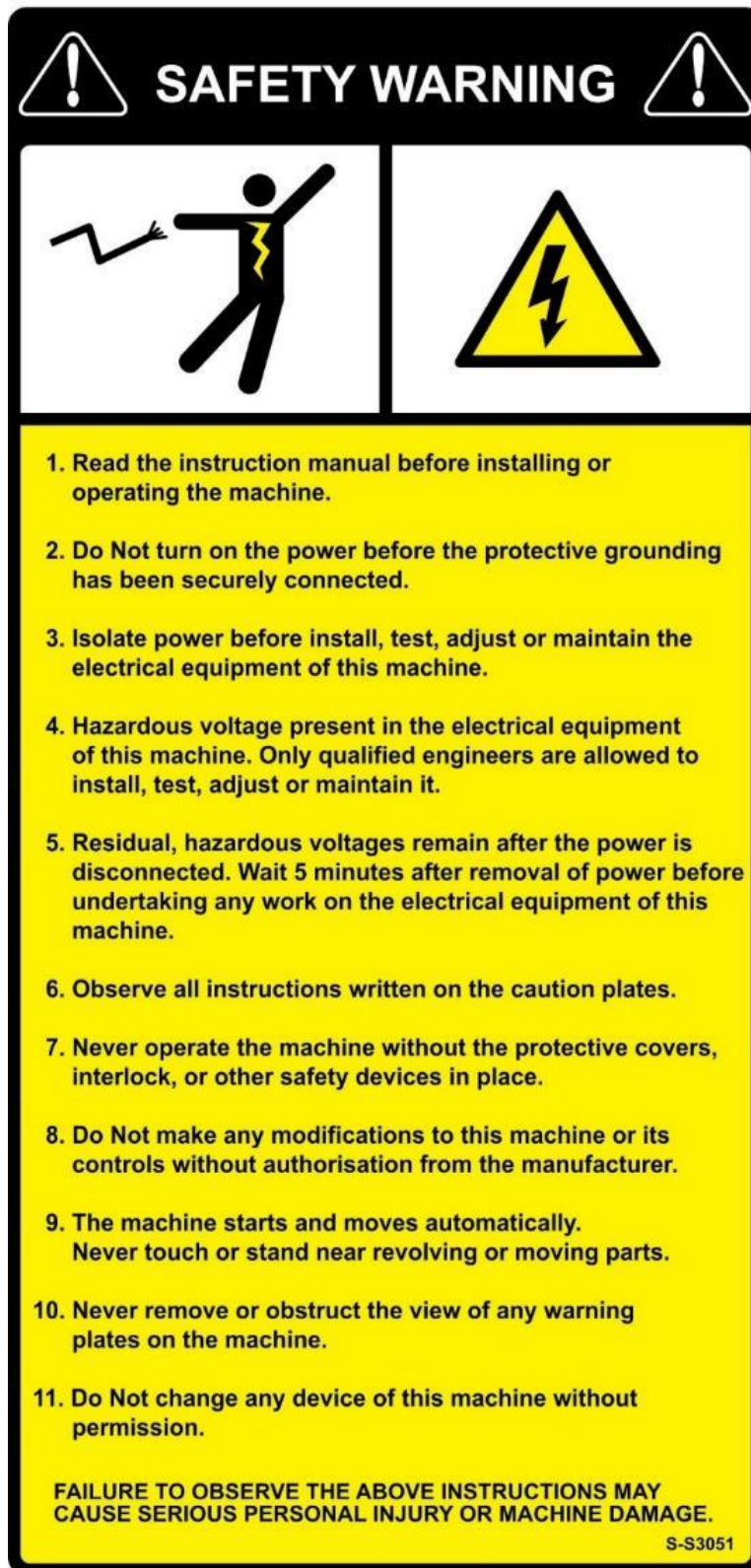

Safety & Information Labels Used on RMX Bed Mills

It is forbidden by law to deface, destroy or remove any of these labels

3.0 Description

3.1 ProtoTRAK RMX Control Specifications

The ProtoTRAK RMX CNC provides you with an extraordinary combination of power and ease of use. Programming and operations are kept simple and at any moment you may select Help Screens or make changes to the programming defaults using the Info Keys.

3.1.1 List of System Specifications

Pendant control hardware

- 2 or 3-axis CNC, 3-axis DRO
- Real handwheels for manual operation
- 15.6" Touchscreen LCD
- Intel® 2.0 GHz processor
- 4 GB Ram
- At least 32 GB of mSATA SSD
- 5 USB connectors
- 2 Ethernet Ports (1 for user and 1 for motion control)
- Override of program Feedrate
- Override of spindle speed
- LED status lights built into run panel
- E-stop
- Spindle Control (FWD, REV, OFF)
- Feed STOP and GO
- Fine vs Course EHW resolution control
- Accessory button to control coolant and AUTO mode in RUN mode
- Power Reset Button to energize the servos
- Headphone jack for video sound (headphones supplied)

Computer Module Control Hardware

- 3 axis motor control – X, Y and Z axis
- Machine I/O connections
- Mill Indexer interface (option)
- User I/O interface (option)

Software Features – general operation

- Clear, uncluttered screen display
- Fly out windows for instant access to features and information
- EPA (Enhanced ProtoTRAK Assistance) for system help
- Programming Defaults to simplify part programming
- Event Options to modify control behavior
- QWERTY touchscreen keyboard
- Calculator places data in programme for you
- Prompted data inputs
- English language – no codes
- Soft keys - change within context
- Windows® operating system
- Selectable two or three-axis CNC
- Color graphics with adjustable views
- Gestures for pan, zoom, rotate
- Inch/mm selectable
- Convenient modes of operation
- Networking

Info Soft Keys

- Status shows current state of the ProtoTRAK RMX
- Tool Table for instant access to tool set ups
- EPA (Enhanced ProtoTRAK Assistance) help information for ProtoTRAK RMX operation
- Math Help to easily calculate missing print data
- Options appear when available while programming
- Defaults to customize the programming style
- Key board to enter alphanumeric and special symbols
- Calculator for simple calculations
- Warnings appear when you must resolve a condition

Status Features

- IN/MM selection
- 2 to 3-axis CNC
- Check current program name
- Check software and firmware versions
- Purchased Options status
- Turn on/off Control Options: Advanced Features, Networking, Electronic Handwheels and Auxiliary Functions

Tool Table Features

- Tool Library for using tools in multiple programs and DRO (option)
- Program Specific Library to manage tools in the current program
- Convenient tool length reference to Base tool
- Tool type reference
- Tool material reference
- # Flutes reference
- Tool Diameter set
- Diameter modifier set
- Z modifier set
- Head Jog and manual quill enabled for quick tool height reference

EPA (Enhanced ProtoTRAK Assistance) Features

- Context sensitive topics for ProtoTRAK RMX control operations
- Keyword search
- Brief explanations of specific operations
- Screen shots for clarity
- Videos for more advanced explanations
- Updated with software release versions

Math Help Features

- 22 separate intuitive routines
- Calculate missing print data using data provided
- Screen Graphics to guide data inputs
- Feed – IPM / MMPM conversions
- Speed – RPM / SFPM conversions
- Cartesian / Polar conversions
- Right triangle calculations
- Load Beg – loads solution as X and Y Begin
- Load End – Loads solution as X and Y End
- Load Centre – Loads solution as X and Y Centre

Programming Defaults

- Instant access to all defaults via fly out window
- Feedrate per Minute or per Tooth

- Spindle speed RPM or Surface Speed
- Peck type for drill events
- Number of Passes for Profile, Pocket and Island events
- Finish Cut for Profile, Pocket and Island Events
- Step over percentages
- Face mill tool path
- Z entry: plunge, helical or zig zag (ramp)
- Adaptive Tool Path selections (options)
- Numerous default parameters for pocket and island events
- Speed and feed overrides for subroutine and copy events
- Forward or Backward Mirror Direction
- Software X, Y and Z limits
- X and Y Home Positions
- Inch or MM
- 2 or 3 axis CNC at start up
- Maximum rapid feedrates
- Accessory On hard key to control Coolant or Mist
- Cut Tolerances
- Tool Compensation

Keyboard Features

- QWERTY style
- Touchscreen operation
- Numbers
- Special characters: \$ @ # ? % () < = * + -

DRO Mode Features for Manual Machining

- Incremental and Absolute dimensions
- Virtual handwheels to control Override of Axis Feed and Spindle RPM
- Jog at rapid with override
- Powerfeed X, Y or Z
- Teach-in of manual moves
- Programmable Go To dimensions (option)
- Servo return to 0 absolute
- Tool offsets from Tool Library
- Line Centre calculation
- Circle Centre calculation

Program Mode Features

- Circular interpolation
- Linear interpolation
- Advanced Adaptive Tool Path (option)
- Geometry programming
- Toolpath programming
- Auto Geometry Engine – Built-in CAD to fill in missing print data for you while you program
- Alphanumeric program names
- Automatic Scaling of print data
- Nesting
- Multiple Fixtures (option)
- Incremental and absolute dimensions may even be mixed on a single point
- Automatic diameter cutter comp
- Look –graphics at all times
- List step – graphics with programmed events displayed
- Program data editing
- Part graphics update while programming

- Selectable display between size of drawing and number of events
- List Step graphics relate Events to Drawing
- Editing of programmed data
- Swipe to move through programmed Events
- Auxiliary functions: Coolant, Pulse Indexer, User Programmable Output signal (option)

Selectable within applicable Events:

- Z Safety plane
- Spindle Speed RPM or SFPM
- Feed rate per minute or tooth
- Event Comments on/off (option)
- Bottom Finish Cut
- Cutting method One Way or Zig-Zag
- Step-over %
- Machining Angle in XY (0 – 90 deg.)
- Drill Peck: Variable, Fixed, Chip Break
- Dwell Request
- Multiple Holes
- Z Entry Plunge, Zig-Zag or Helical
- Tool path Pattern: Offset, Parallel
- Tool path Pattern: Adaptive (option)
- Order of Passes: Depth or Region
- Insert Clipboard data
- Cut Tolerances

Canned Cycles (Event types):

- Position
- Drill / Bore / Tap
- Bolt Hole Drill / Bore / Tap
- Mill
- Arc
- Circular profile
- Rectangular profile
- Irregular Profile (with Auto Geometry Engine)
- Face Mill
- Circle pocket
- Rectangular pocket
- Irregular Pocket (with Auto Geometry Engine)
- Islands including Pocket and Island shapes
- Subroutine Repeat
- Subroutine Mirror
- Subroutine Rotation
- Copy (option)
- Copy Mirror (option)
- Copy Rotate (option)
- Copy Convert Drill to Tap (option)
- Helix
- Engrave (option)
- Engrave subroutines and copy (option)
- Thread Mill (option)
- Program pause
- Aux Event

Edit Mode Features

- Group Delete of Events

- Search Edit to make changes to multiple events
- Erase current program
- G-Code Editor (option)
- Clipboard to copy events for insertion elsewhere

Set-up Mode Features

- Toolpath graphics with selectable views
- Estimated Run Time clock
- Step forward and backward through of Toolpath graphics
- XYZ tool position locations displayed in Step through mode
- Verify Make Part – solid model graphics of programmed toolpath (option)
- Verify View Part – solid model of finished part
- Fixture offsets – convenient table for managing fixtures with DRO and Jog
- Ref Position – convenient table for setting Retract, Homes and software limits
- Service Codes for infrequent machine and control settings

Run Mode Features

- 3D CAM file run
- 3D G code file run
- Override of Programmed Axis Feed and Spindle Speed from 0 – 150%
- Virtual handwheels to control Override
- Tap override of Axis Feed and Spindle RPM
- Real time conversion of programmed RPM / SFM
- Real time conversion of programmed IPM / IPT
- Status display:
- Event #
- Fixture#
- Control system Ready
- Current Tool #
- Repeat #
- Countdown clock to next pause or tool change
- Event Comments
- Start at beginning
- Start at any Event
- Start at tool # for GCD programs
- Start at rough or finish pass
- Start at any finish cut for pockets and islands – XY, Z, XY & Z
- Show Absolute Dimensions during run
- Show Incremental Dimensions
- Show Tool Path – real time graphics with Tool icon
- Show Program
- TRAKing® - you control programmed X,Y and Z feeds with Electronic Handwheels (option)
- Chip Clear (option)

Program In/Out Mode features

- Program storage to USB device plugged into Control Pendant
- Program storage to Network via RJ45 Port
- Browse file locations
- Create New Folders
- CAM program converter
- Convert prior-generation ProtoTRAK programs to current (.PT10)
- Save Temp – saves all current programs, tools and other settings
- Open Temp – opens the data saved at last "Save Temp"
- Rename programs
- Cut, Copy, Delete, Paste of program(s)

- Look - Graphics preview without opening files

Advanced Features Option

- Adaptive Pocket Roughing
- Verify Make Part – solid model graphics of programmed toolpath
- Multiple Fixtures
- Event Comments
- G-code editor
- Thread Mill event
- Engrave Event
- Copy Repeat
- Copy Mirror
- Copy Rotate
- Copy Convert Drill to Tap
- Tool Library for using tools in multiple programs and DRO
- Chip Clear
- Rest Material

Auxiliary Functions Option

- Enables programming and control of:
 - Coolant
 - Pulse Indexer
 - Programmable Output signal

DXF File Converter Option

- Import and convert CAD data into ProtoTRAK programs
- DXF or DWG files
- Chaining
- Automatic Gap Closing
- Layer control
- Part alignment
- Feature analysis (circle/arc radius and position)
- Simple CAD construction/editing tools
- DXF-output capability
- Easy, prompted process you can do right at the machine

Parasolid File Converter Option

- Import and convert 3D CAD data into ProtoTRAK programs
- X_T files
- X, Y & Z dimensions are transferred into program events
- 2D and 3D views of part
- Add or remove geometry
- Chaining
- Part alignment
- Feature analysis (circle/arc radius and position)
- Simple CAD construction/editing tools
- Easy, prompted process you can do right at the machine

TRAKing® / Electronic Handwheels Option

- Available on all XYZ Bed Mills
- TRAKing® of programs during program run
- Go To Dimensions in DRO Mode
- Scalable Fine/Course handwheel resolution

Offline Programming Option

- ProtoTRAK RMX user interface for Windows PC
- Program parts and simulate CNC Run
- Modify files from current and former ProtoTRAK models

3.2 ProtoTRAK RMX Options

You may purchase software options with the original machine purchase or later. If you purchased them with your original order, they should come pre-installed from our factory. You can easily tell if you have an option activated on your control by pressing the Status Key. You can also see all the available options by referring to Service Code 318 (see below).

To purchase Software Options, call XYZ Machine Tools on 01823 674200 for pricing and to place your order. Before you install the option, we recommend that you first assure that you are running the most recent version of the ProtoTRAK RMX.

Once you purchase the option, we will give you an Activation Code.

1. Go to the Set-up Mode
2. Select Serv Codes
3. Enter 318, Inc Set or Abs Set
4. Tap the option you want to activate from the list.
5. When prompted, enter the Activation Code.

3.2.1 Advanced Features

In order to make the ProtoTRAK RMX easier for a basic user, we have segmented some of the more complex features into an Advanced Features Option. Advanced Features, once installed, may be turned off or on in the Status Fly Out window.

3.2.2 TRAKing® / Electronic Handwheels

Electronic Handwheels are required for TRAKing®, manual Go To, and Fine / Course handwheel resolution. They replace the direct manual control of the ball screw with an encoder that sends a signal to the computer, which then commands the appropriate response from the axis motor. Electronic Handwheels are active only in DRO Mode, Set up Mode to set tools and reference locations and Run Mode for TRAKing® and Chip Clear. Otherwise, the machine will not respond to the movement of the handwheel.

You may easily turn the Electronic Handwheels on or off through the Status Information Screen.

3.2.3 DXF File Converter Option

The DXF File Converter Option gives you powerful capability for quickly and easily translating DXF and DWG files into ProtoTRAK RMX programs. If you work with CAD drawings, we highly recommend the DXF file converter.

The DXF File Converter Option has its own manual which is shipped with the software. You may also view a copy of the manual on our web site at www.xyzmachinetools.com.

3.2.4 Parasolid File Converter Option

The Parasolid File Converter Option gives you a powerful capability for quickly and easily translating Parasolid files (X_T) into ProtoTRAK RMX programs. If you work with 3D Solid Model CAD drawings, we highly recommend the Parasolid file converter.

The Parasolid Option has its own manual which is shipped with the software. You may also view a copy of the manual on our web site at www.xyzmachinetools.com.

3.2.5 Verify Option

Part Verify allows you to see a solid model rendition of your programmed part as well as the programmed toolpath. It is very useful to prove out a program and prevent mistakes.

3.3 Display Pendant

3.3.1 Front

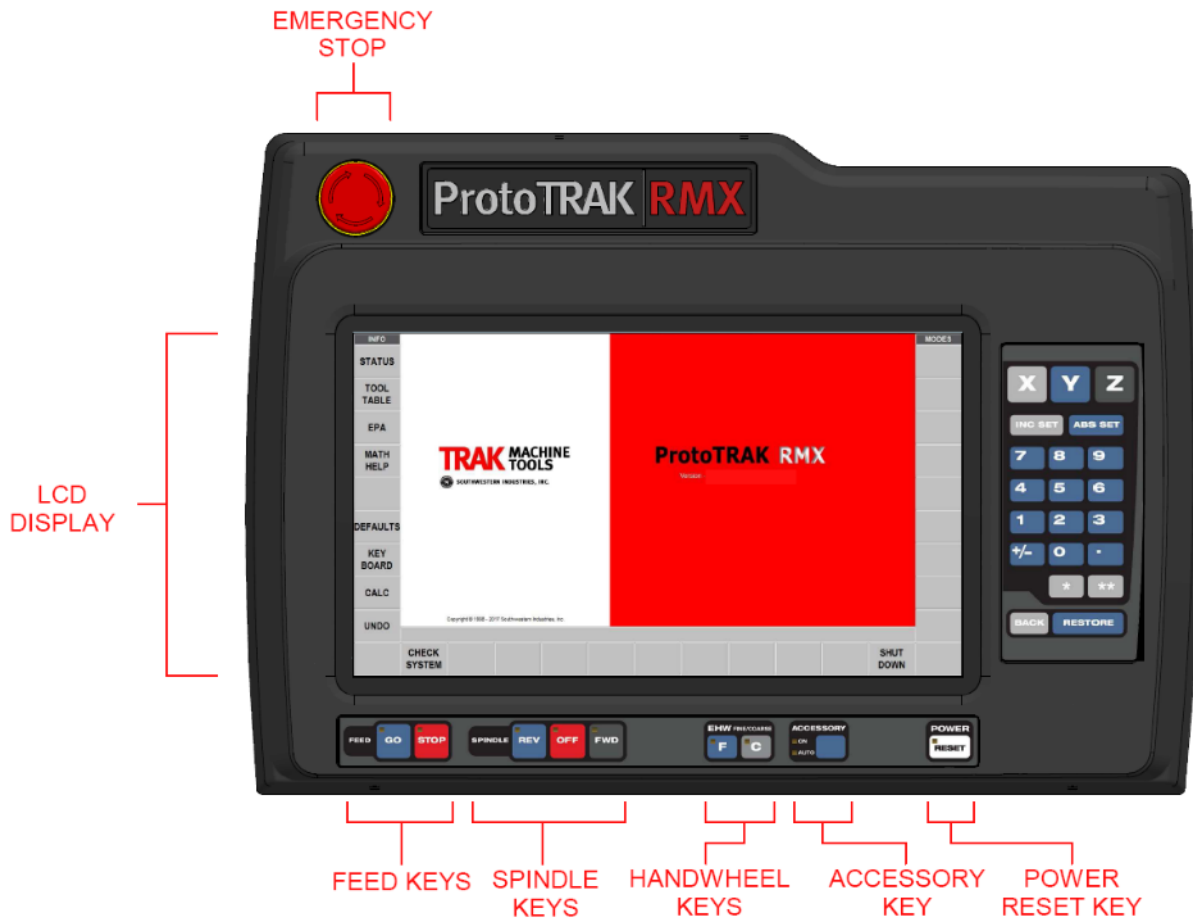

Figure 3.2.1 *The front of the ProtoTRAK RMX Control Pendant*

Keyboard Hard Keys

- X, Y, Z:** selects axis for subsequent commands
- INC SET:** loads incremental dimensions and general data
- ABS SET:** loads absolute dimensions and general data
- 0-9, +/-, . :** inputs numeric data with floating point format. Data is automatically + unless +/- key is pressed. All input data is automatically rounded to the system's resolution
- RESTORE:** clears an entry, aborts a keying procedure
- BACK:** Moves back within the screen or the DIL when there isn't a better way to do it.
- * **KEY** – Not used at this time.
- ** **KEY** – Not used at this time.

Feed Keys:

- GO:** initiates motion in Run. The green LED on the GO key will be lit when the servomotors are moving the machine or when the program run has been initiated by the GO key.

STOP: halts motion during Run. The red LED on the STOP key will be lit when the servos motors are not moving the machine.

Spindle Keys:

REV: runs the spindle in reverse at programmed speed with any override.

OFF: Turns spindle off and servo brakes to a stop.

FWD: runs spindle in the forward direction at programmed spindle speed with any override.

EHW FINE/COURSE:

Selects the resolution for the Optional Electronic Handwheels.

C: moves the table at 20mm (0.800") per revolution for X,
moves the saddle at 20mm (0.800") per revolution for Y

F: moves the table at 5mm (0.200") per revolution for X,
moves the saddle at 5mm (0.200") per revolution for Y

ACCESSORY: When the switch is in the On position, the coolant pump will come on and stay on during machining operations. It will not turn off during tool changes.

POWER / RESET: the LED on indicates there is power to the servo motors. After starting the ProtoTRAK, press and hold this key until the white LED illuminates on the RMX to initiate. This button will need to be pressed any time the control gets into a critical fault condition. An example of this would be if the user presses the Emergency Stop button.

Keyboard Soft Keys

Once the ProtoTRAK RMX pendant has booted up, the soft keys are enabled and operated by the touchscreen.

Fly Out Windows

Touching one of the INFO Soft Keys initiates another window to open (or "fly out"). When one of these windows is active, the associated INFO Soft Key will be yellow. In order to put the window away, or switch to another Fly Out Window, press the INFO Soft Key again.

Warnings are also presented in a Fly Out Window. When a Warning appears, you must press the Clear soft key to dismiss the warning.

3.3.2 Display Back

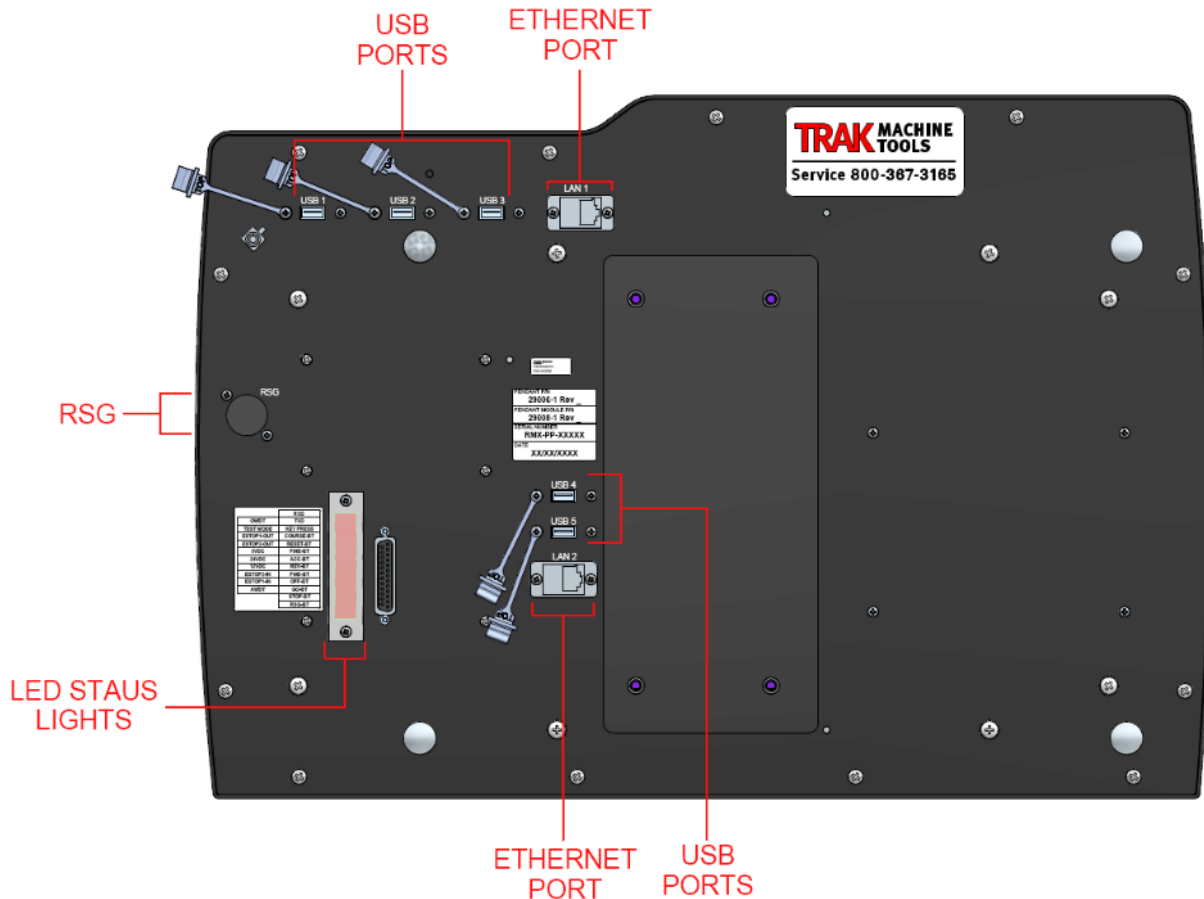

Figure 3.2.2 Back of the Pendant

Installing and using the USB Thumb Drive Flash Memory

The first time you install the USB Thumb Drive, we recommend that you install it after the ProtoTRAK RMX has booted up. Once it is installed, the memory will be accessible on Drive D. If you want to buy additional thumb drives, these are readily available in computer stores. We recommend SanDisk® brand, 2 GB or higher. Other brands may require the installation of separate drivers.

RMX Option Key

Each ProtoTRAK machine will come with an USB Option Key that is plugged into the USB port above the lower Ethernet port. This key must be plugged in to allow certain standard software features to work and also to allow optional software features to work.

3.4 Machine Specifications

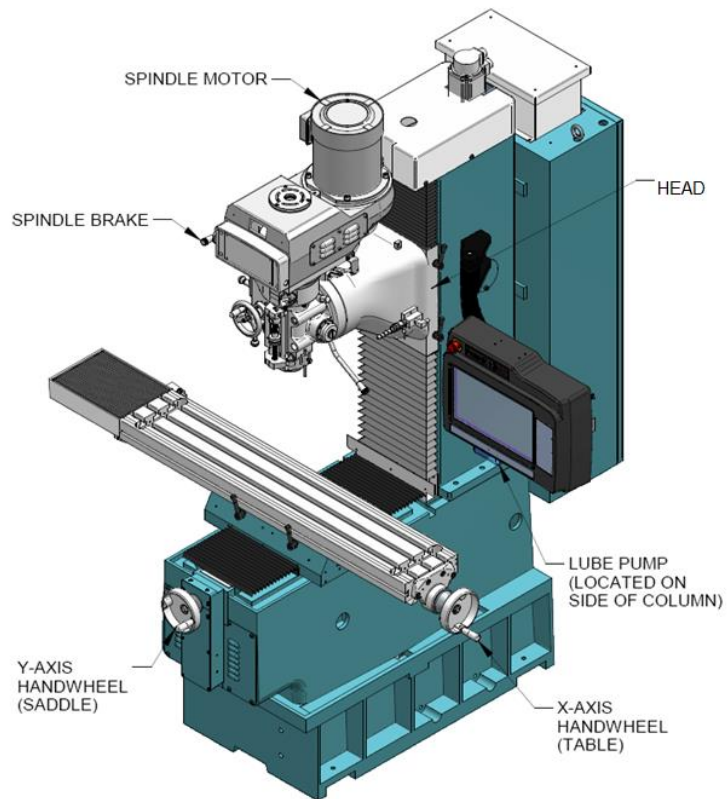

Figure 3.4.1 RMX 2500 Front View

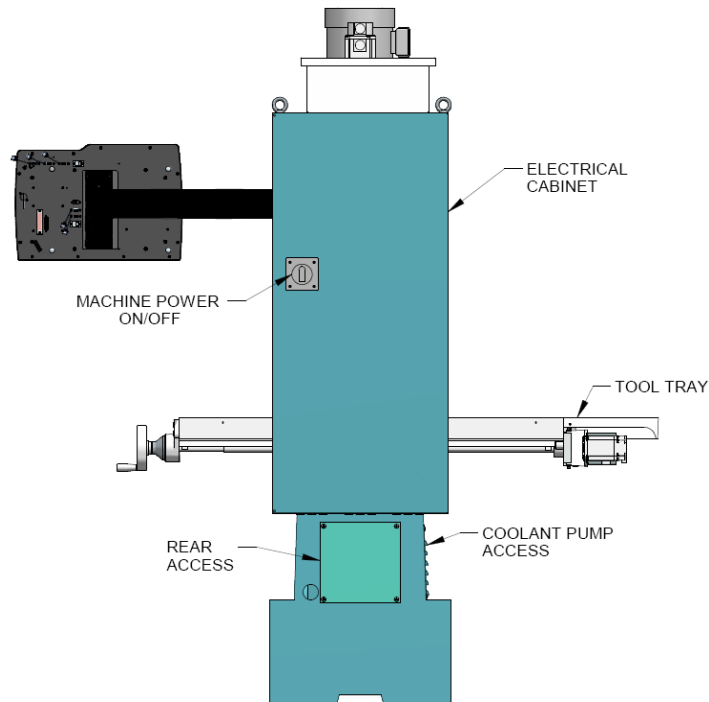

Figure 3.4.2 RMX 2500 Back View

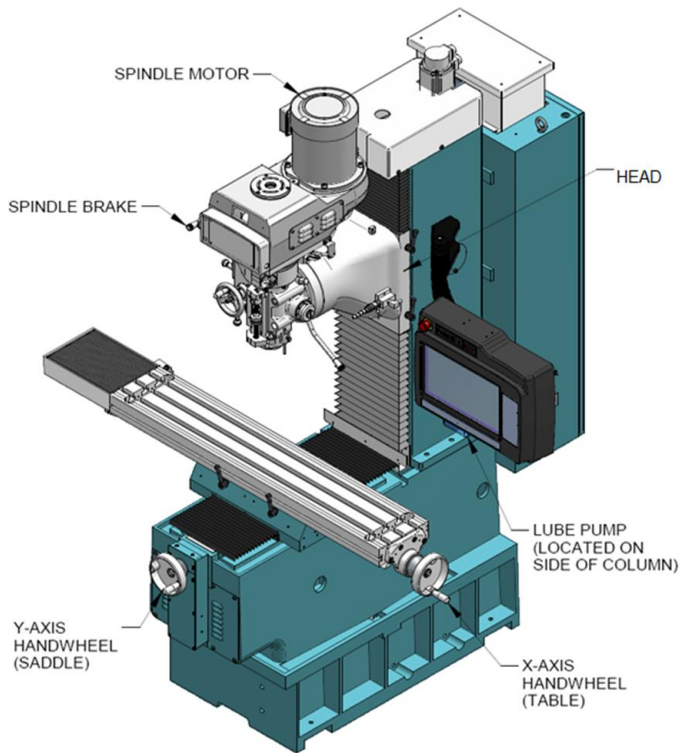

Figure 3.4.3 RMX 3500 Front View

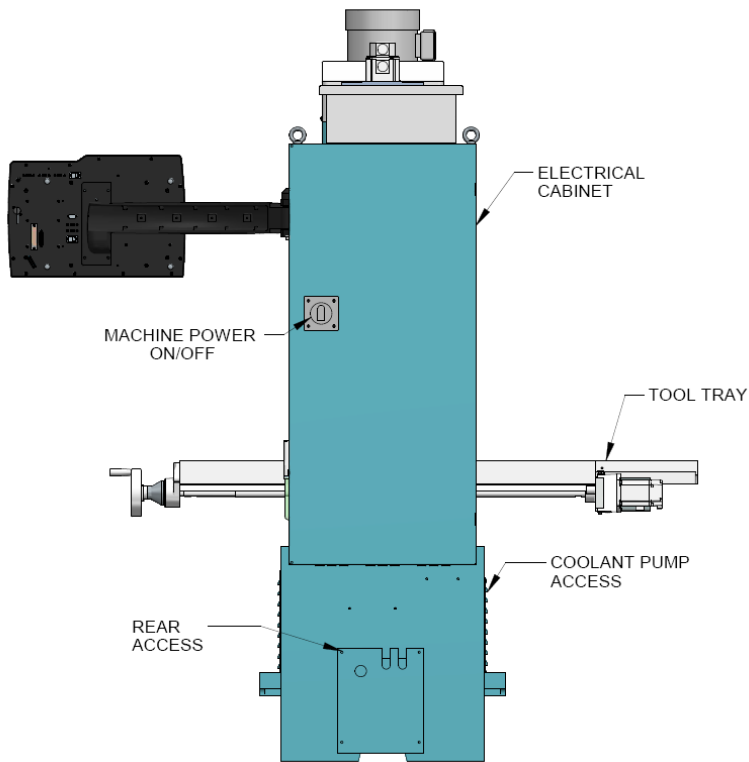

Figure 3.4.4 RMX 3500 Back View

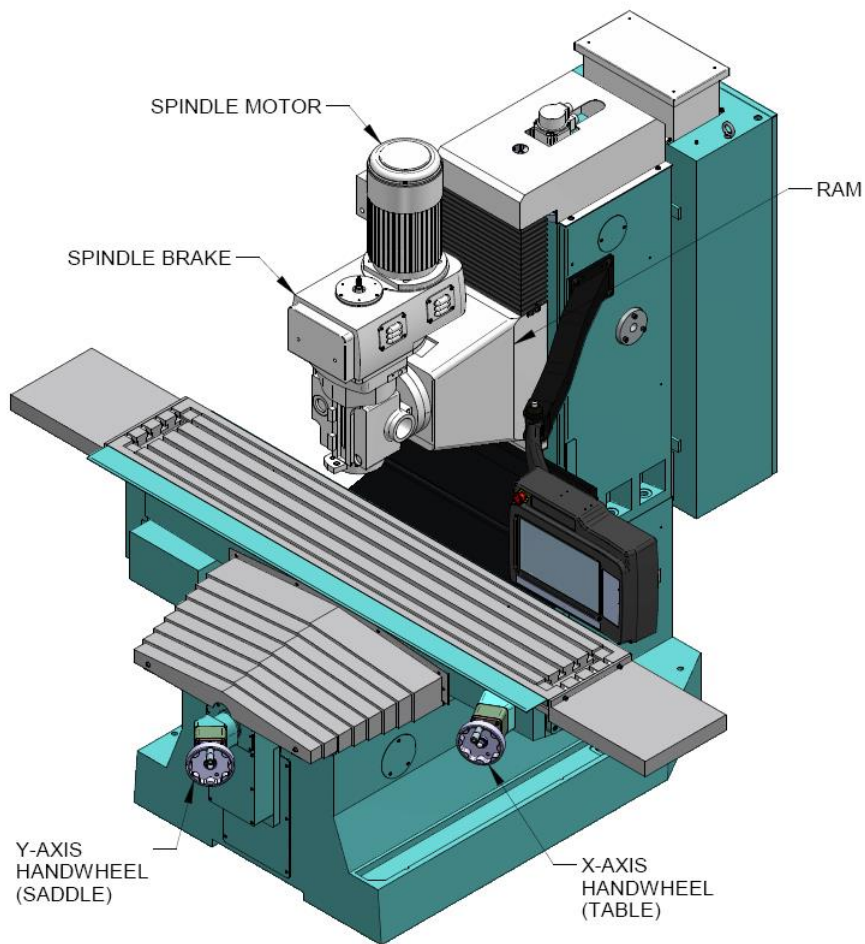

Figure 3.4.5 RMX 4000/5000 Front View

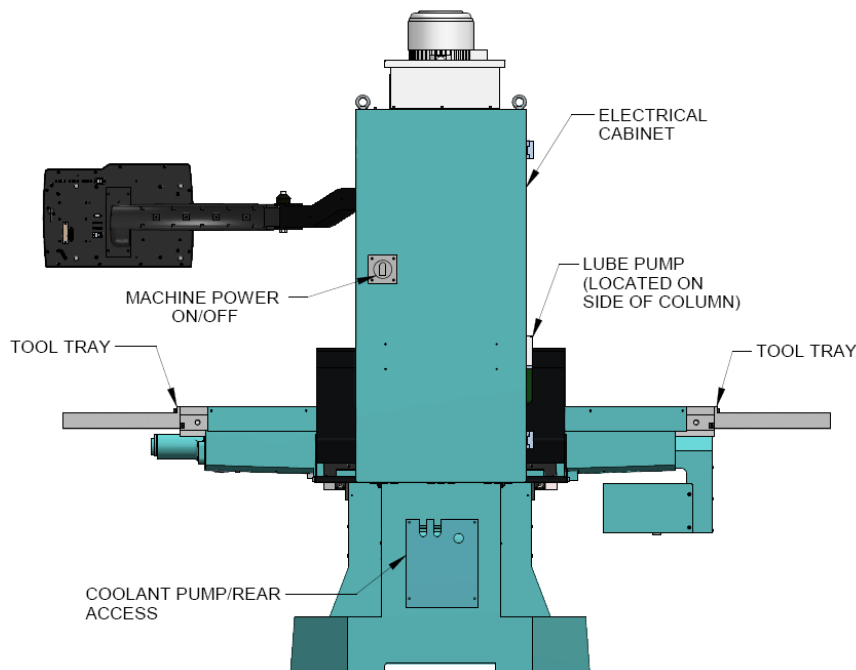

Figure 3.4.6 RMX 4000/5000 Back View

XYZ Bed Mill Specifications (in mm)

Model Name	2500	3500	4000	5000
Table Size	1245 x 229	1372 x 356	1474 x 356	1930 x 355
T-Slots (number x width x pitch)	3 x 16	4 x 15.9	4 x 15.9	4 x 15.9
Travel (X, Y, Z axis)	675 x 400 x 540	787 x 508 x 450	1016 x 596 x 520	1524 x 596 x 520
Quill Diameter	86	105	116	116
Maximum Quill Travel	122	127	127	127
Spindle Taper	R8	40 ISO	40 ISO	40 ISO
Spindle Speed Range	40 - 4200	40 – 5000	40 - 5000	40 - 5000
Spindle Centre to Column Face	457	520	610	610
Spindle Motor Power (kW)	2.2	3.75	5.5	5.5
Machine Power requirements (400V, 3 phase)	19 Amp	22 Amp	27 Amp	27 Amp
Maximum Weight of Workpiece	600 Kg	600 Kg	850 Kg	850 Kg
Height of table from bottom of bed	926	840	956	956
Max spindle nose to table	605	625	540	615
Space Claim (W x D x H) (excluding working clearances)	2190 x 1866 x 2335	3600 x 3143 x 2400	4405 x 3143 x 2530	5805 x 3143 x 2530
Weight	1850 Kg	2390 Kg	3520 Kg	3570 Kg
rapid traverse (mm/min) X, Y, Z – manual handwheels	3800	3800	3800	3800
Rapid traverse (mm/min) – electronic handwheels	X, Y	10160	10160	10160
	Z	6350	6350	6350

Maximum Work Capacities in Mild Steel

Model Name	2500	3500	4000	5000
Drilling max capacity	25mm	25mm	25mm	25mm
Milling max capacity	50 cm ³ /min	80 cm ³ /min	120 cm ³ /min	120 cm ³ /min
Tapping max capacity	M24	M24	M30	M30

3.5 Standard Equipment

- Table Guard
- Air Powered Drawbar
 - The thread on the drawbar is 5.8" on the RMX 2500 and M16 thread on the RMX 3500, RMX 4000 and RMX 5000.
- LED Worklight
- Coolant Pump
 - May be configured to operate as commanded by the auxiliary functions, or with the Accessory ON button on the run panel
- Limit switches:
 - There are limit switches for the head, saddle and table travel.
- Swarf Tray and splash shields

3.6 Optional Equipment

3.6.1 Electronic Handwheels

When ordered as part of the TRAKing/Electronic Handwheels Option (see Section 3.2.2) the electronic handwheels replace the standard mechanical handwheels for table and saddle traverse. The electronic handwheels will operate when the ProtoTRAK RMX CNC is in a Mode where the machinist controls the motion of the table and saddle. This includes the DRO Mode, the Set-Up Mode and the TRAKing operation in the Run Mode. The electronic handwheels will not operate during other functions, such as edit or program in/out mode.

Handwheel resolution is determined by the F/C key on the display. Fine feed moves 5mm per revolution, Course feed moves 20mm per revolution.

3.6.2 Auxiliary Functions

Auxiliary functions are controlled through the ProtoTRAK RMX CNC either in the program or with the accessory key on the front panel. The Auxiliary functions consist of the following:

- Coolant
- Pulse Indexer
- Programmable User Output signal

3.6.5 Remote Stop Go Switch

For the convenience of operation while running the program, a Remote Stop/Go switch may be purchased. This switch is on a 3m cable and operates like the FEED Stop and Go keys on the display.

3.5.10 30-Taper Spindle

For the RMX 2500, the standard R8 spindle may be replaced by an ISO 30-taper spindle.

3.6 Lubrication System

The way and ballscrew lubrication pump is activated automatically by the CNC control system based on axis activity. The pump may also be activated manually in Service code 300 and also turns on once, each time you turn on your machine.

Factory Default Values

Interval Time – 20 min.

Discharge Time – 15 sec

Discharge Pressure – Approximately 100 – 150psi

To adjust the amount of Discharge Pressure displayed on the lube pump gauge, loosen the jam nut and turn the adjustment screw located on the top right side of the lube pump while the lube pump is activated.

CAUTION!

Failure to properly lubricate the mill will result in the premature failure of bearings and sliding surfaces.

The settings for the lube pump can be viewed and adjusted in Service Codes. Go to:

SET UP Mode

SERV CODES

E: Lube Pump Setup

Enter:

300 to Manually activate the pump

301 to set the cycle time (length of time between automatic discharges)

302 to set the amount of time of the automatic discharge

3.7 Electrical Cabinet

The Electrical cabinet is mounted to the rear of the column; containing the CNC computer module and the machine electrical equipment. The main, electrical isolator (on/off switch) is fitted to the cabinet. The incoming supply cable (responsibility of the customer) is terminated at this isolator.

The bed mills require a 400V, three phase and Earth power connection. See the machine plate for more details.

3.8 Integrated Head and Quill Encoders

A Linear scale for the Quill is standard. Head (Z) motion is measured by an encoder on the Z axis servo motor. The feedback from these encoders is integrated and displayed in the Z-axis digital readout as one dimension.

3.9 Servo Motors

On the RMX 2500 and RMX 3500, the servo motors for table and saddle are 750 watt brushless motors. The motor driving the head is a 1000 watt brushless motor. The RMX 4000 and 5000 uses 1000 Watt motors on all 3 axes. The linear resolution of the motors encoders depends on the ballscrew pitch and pulley ratio between the motor and ballscrew, but is always better than 0.1microns. For this reason, we do not recommend fitting linear scales (with a typical resolution of 5microns). Better, is to spend money on regular maintenance and overhaul to ensure the performance is maintained as the machine ages.

4.0 Basic Operation

The TRAK RMX Bed Mills have been designed to give you unprecedented power in a CNC user experience that is natural and easy to use. This section will walk you through some basics of using the ProtoTRAK RMX CNC.

4.1 Powering Up the System

To turn on power to the entire machine and control system, rotate the power switch on the Electrical Cabinet to the On position.

The control will go through its boot up sequence. When it is finished, the following screen will appear.

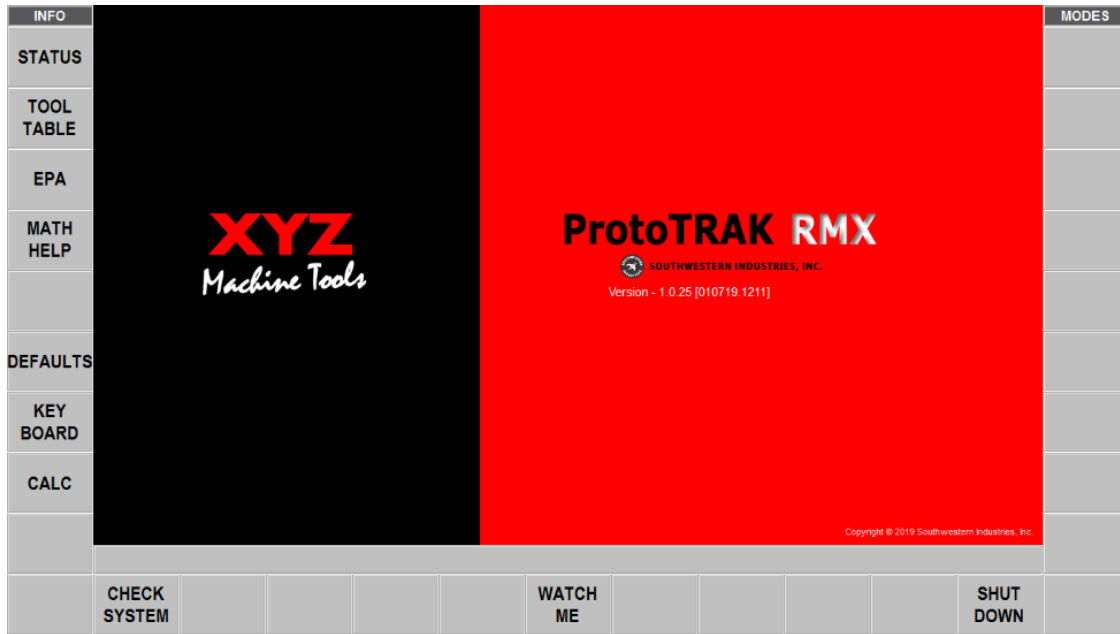

Figure 4.1 The ProtoTRAK RMX will display this screen after it boots up.

To begin using the ProtoTRAK RMX CNC, first do the following:

Tap the Check System soft key.

Press the POWER Reset hard key and hold it for a few seconds until the white LED comes on.

4.2 Shutting down the ProtoTRAK RMX CNC

Important: The system must be turned off properly or you may lose unsaved data such as programs or certain machine configurations. The SHUT DOWN soft key will initiate the process of shutting down safely. When the screen goes blank, turn the power switch at the back of the electrical cabinet to the Off position.

In order to reach the SHUT DOWN soft key, first close any Fly Out Windows that are open. We also recommend that you complete any prompted activity, such as programming an Event. Press the BACK hard key repeatedly until you get to the screen shown in Figure 4.1 above.

The ProtoTRAK control should be shut off at a minimum every few days. Failure to reboot may cause the control to run slowly. For example, the INFO screens may move in and out slowly. This is a sign the control

should be restarted. Take advantage of the SAVE TEMP feature prior to shut down as mentioned in the note below.

Note: You can save your current positions, tool information and program using the Save Temp feature in the Program In/Out mode.

4.3 Operator Run Keys

4.3.1 Feed

The Feed Keys control the Go or Stop of programmed toolpath in the Run Mode. When running a program in the Run Mode, you will be prompted for when to start the feed by pressing the GO button.

WARNING!
Pressing the GO button will initiate automatic machine motion!

4.3.2 Spindle Control

The Spindle Forward/Off/Reverse is controlled through the Spindle hard keys just below the screen. Spindle RPM is controlled through inputs in the DRO and Program Modes.

To set the spindle RPM Range adjust the Spindle Range Lever on the upper right side of the head to High or Low.

The spindle will not operate unless the ProtoTRAK RMX CNC is in the DRO or Run Modes (and table guards are closed).

4.3.3 EHW Fine/Coarse

These buttons are used for machines that have Electronic Handwheels.

F or Fine:

- in DRO Mode – 5 mm per handwheel revolution
- in Run Mode with TRAKing®

C or Coarse:

- in DRO Mode – 20 mm per handwheel revolution
- in Run Mode with TRAKing®

4.3.4 Accessory

When the switch is in the On position, the flood coolant pump will come on and stay on during machining operations.

In the Auto mode, the coolant pump will be controlled as programmed by the Optional Auxiliary functions. To get to the Auto operation, press and hold the Accessory key.

If neither light is on, the coolant pump will not operate.

4.3.5 Power / Reset

Push and hold for a few seconds to initialize power to the X, Y and Z servo and motors. This is required after start up, after an Emergency stop or any critical fault.

4.4 Manual Operation of the Head, Table and Saddle.

When the Electronic Handwheels are installed, the mill may be used manually while in the DRO Mode. Manual positioning and jog are active in other situations when needed, such as when setting tools.

When not in the DRO Mode, moving the Electronic Handwheel will not result in movement of the machine.

4.5 Emergency Stop

Press the button to shut off power to the spindle motor and axis motors. Rotate the switch to release. You may also want to press in the Emergency Stop at the end of the day if you would like to leave the machine on but prevent operation of the machine electrical equipment.

You must reset the power after each Emergency stop by pressing and holding the Power/Reset hard key.

4.6 Switching between Two and Three-axis Operation

You may use the RMX bed mill as a two or three-axis CNC. To switch, tap the Status soft key and tap the box labelled AXIS MODE. See Section 6 for more information about the Status and other Info keys.

4.7 Data Input Keys

Data Input keys (hard keys) are used to input numeric data as either an Absolute or Incremental reference.

4.8 Modes

The Modes soft keys are always active. With the ProtoTRAK RMX it is always possible to switch freely between Modes once you close any Fly Out window.

As you move into and out of a Mode, the operations will almost always be where you left them the last time you went out.

This manual will deal with each Mode thoroughly in the Sections following.

4.9 Gestures

The touchscreen is operated with the following gestures:

Tap – Tap is used to select an item such as an Info Key. To Tap, lightly touch the screen with one finger.

Double Tap – in Program In/Out mode, double tapping will open a file or folder.

Swipe – Swipe is used to move from one screen to another, for example you move forward and back through Events in the Program Mode with swipes. To Swipe, touch the screen with one finger and move rapidly in the direction you want to move.

Pan – Pan is used to move content, such as a part drawing, around the screen. To Pan, touch the screen with one finger and move slowly in any direction.

Spread / Pinch - these gestures are used to zoom in or out of a drawing. Use your thumb and finger.

Touch and Hold – Touch and hold works much like the right click of a mouse to initiate a pop up menu for selections, when one is available. Touch the screen item and hold for 2 seconds.

Drag – Drag is used to move some of the information windows to more convenient location on the screen. Touch the window header or title area and drag it to where you want.

Rotate – Rotate is used to rotate a drawing or a solid model. Touch the screen with 2 fingers and twist to rotate the part along and axis projecting out of the screen. Move your 2 fingers to the right to rotate around a vertical line on the screen. Move your 2 fingers to the left to rotate around a horizontal line on the screen. Move your 2 fingers CW or CCW on the screen to rotate around a point.

5.0 Definitions, Terms & Concepts

5.1 ProtoTRAK RMX CNC Axis Conventions

Direction of axis movement is always from the point of view of the tool, so:

X Axis: positive X-axis motion is defined as the table moving to the left when facing the mill. Consequently, measurement to the right is positive on the workpiece.

Y Axis: positive Y-axis motion is defined as the table moving toward you. Measurement toward the machine (away from you) is positive on the workpiece.

Z Axis: positive Z-axis motion is defined as moving the head up. Measurement up is also positive on the workpiece.

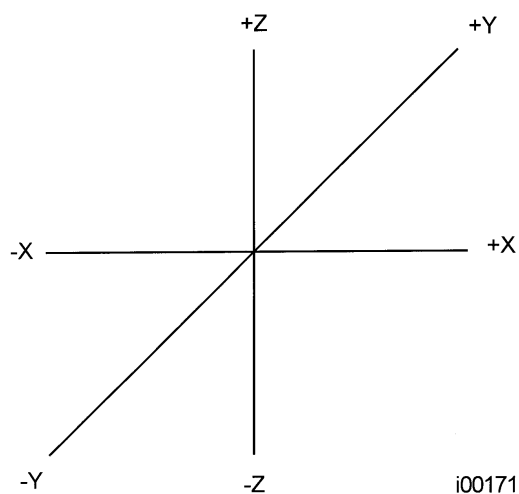

FIGURE 5.1 ProtoTRAK RMX CNC conventions

The Z RAPID dimension is the position at which Z will stop rapid motion and switch to its programmed Z feedrate. Z motion will continue until Z End depth has been reached.

5.2 Part Geometry & Tool Path Programming

The ProtoTRAK RMX CNC gives you ultimate flexibility in programming. Programmes that are entered through the ProtoTRAK system can be entered as either Part Geometry or Tool Path.

Part Geometry programming is the popular programming style of the ProtoTRAK family of products. This is done by defining the final geometry of the part, and the ProtoTRAK RMX CNC works out the tool path from the part dimensions and the tool set-up information. This is a great benefit compared to regular CNC because it doesn't force the programmer to do the difficult job of defining tool path. A consequence of part geometry programming is that the following are not allowed:

- connection of an incline plane and another event,
- connection of two events that lie in different planes.

Using Geometry Programming, it is impossible for the ProtoTRAK RMX CNC to calculate a tool path for these cases without creating a problem; in cutting the geometry desired in the first event, the tool ends up out of position for the next event. Resolving the difference in tool position where the first event ends and the next event begins means either the CNC calculates and makes an unprogrammed move, or it retracts the tool out and then back into the part.

These cases are not encountered often, but when they are, you have the option of using Tool Path programming. In Tool Path programming you define the events the same way, but all inputs are treated as tool centre. It is your job to calculate and program the tool path.

Programs generated by CAD/CAM systems are always generated as Tool Path programs and are run as such even if the Advanced Features Option is not active on the ProtoTRAK RMX CNC.

5.3 Planes and Vertical Planes

A plane is any flat surface. If that surface lies flat on the table, it is the XY plane. That is, if you move your finger along that surface or plane, you are moving in the X and/or Y direction, but not in Z. If you tilted that surface (think of it as a piece of paper) straight up so that it faces the front of the machine, it would be in the XZ plane. If you tilted it up so that it faced left or right, it would be in the YZ plane.

A vertical plane is any plane (or surface) tipped up on its edge on the table (see below).

Unlike most CNC controls, the ProtoTRAK RMX CNC can machine arcs in any vertical plane rather than just XZ or YZ.

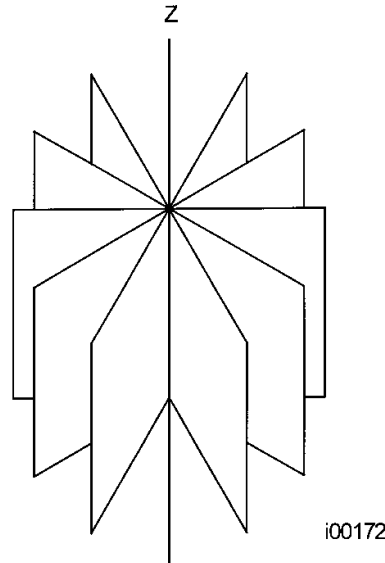

FIGURE 5.3 Vertical planes

5.4 Absolute & Incremental Reference

The ProtoTRAK RMX CNC may be programmed and operated in either (or in a combination of) absolute or incremental dimensions. An absolute reference from which all absolute dimensions are measured (in DRO and program operation) can be set at any point on, or even off, the workpiece.

To help understand the difference between absolute and incremental position, consider the following example:

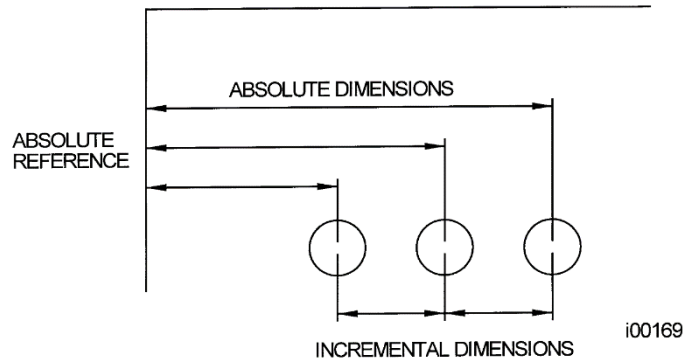

FIGURE 5.4 Each point has both an absolute and an incremental reference in the X axis. The ProtoTRAK RMX CNC allows you to program using either.

5.5 Referenced & Non-Referenced Data

Data is always loaded into the ProtoTRAK RMX CNC by using the INC SET or ABS SET key. X, Y, Z positions are referenced data. In entering any X, Y, or Z position data, you must note whether it is an incremental or absolute dimension and enter it accordingly. All other information (non-referenced data), such as tool diameter, feedrate, etc. is not a position and may, therefore, be loaded with either the INC SET or ABS SET key. This manual uses the term SET when either INC SET or ABS SET may be used interchangeably.

5.6 Incremental Reference Position in Programming

When X, Y, Z RAPID and Z data for the beginning position of any event are input as incremental data, this increment must be measured from some known point in the previous event. Following are the positions for each event type from which the incremental moves are made in the subsequent event:

Position: X, Y and Z programmed

Drill: X, Y, Z RAPID, and Z END programmed

Bolt Hole: X CENTRE, Y CENTRE, Z RAPID and Z END programmed

Mill: X END, Y END, Z RAPID and Z END programmed

Arc: X END, Y END, Z RAPID and Z END programmed

Circle (POCKET or FRAME): X CENTRE, Y CENTRE, Z RAPID and Z END programmed

Rectangle or Irregular (POCKET or PROFILE): X1 and Y1 corner, Z RAPID and Z END programmed

Helix: The X END, Y END, Z RAPID, and Z END programmed.

Sub: The reference position as defined for the specific events above for the event prior to the first event that was repeated.

A.G.E. PROFILE: The appropriate reference position as defined for the specific events above for the last event that is programmed. A.G.E. Profile Programming requires the Advanced Features Option.

For example, if an ARC event followed a MILL event, a 20mm incremental X BEG would mean that in the X direction the beginning of the ARC event is 20mm from the end of the MILL event.

5.7 Tool Diameter Compensation

Tool diameter compensation allows the machined edges shown directly on the print to be programmed instead of the centre of the tool. The ProtoTRAK RMX CNC then automatically compensates for the programmed geometry so that the desired results are obtained.

Tool cutter compensation is always specified as the tool either right or left of the workpiece while looking in the direction of the tool motion.

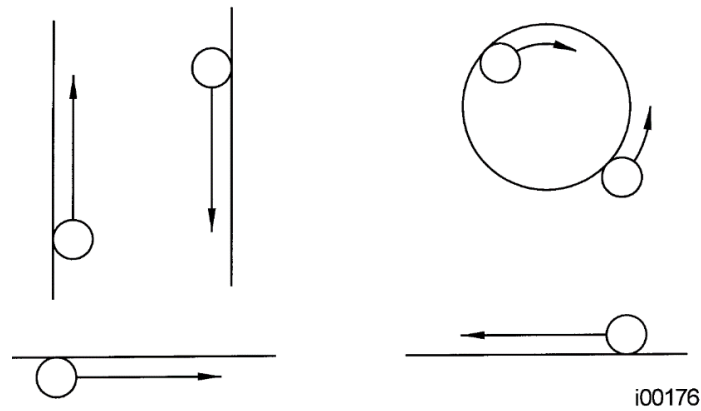

FIGURE 5.7.1 Examples of tool right

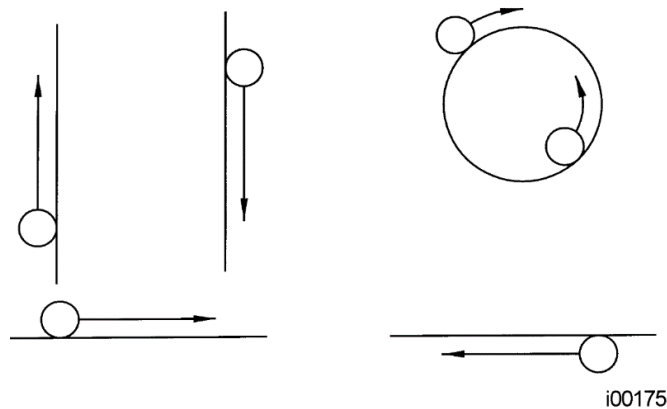

FIGURE 5.7.2 Examples of tool left

Tool centre means no compensation either right or left. That is, the centerline of the tool will be moved to the programmed points.

5.8 Tool Diameter Compensation when Contouring in Z with Part Geometry

Left and right tool diameter offsets are always those projected into the XY plane. Tool offsets in the Z direction are always up and assume the use of a ball end mill. When contouring in the Z-axis, this up tool offset is always activated regardless of left, right, centre if the Part Geometry option is selected. There is no Z-axis up tool offset applied when the Tool Path option is selected.

Special attention must always be paid to tool offsets when machining with a ball end mill. The reason for this is that the tool diameter changes in the bottom part (that portion equal to the tool radius) of the tool.

The tool is always positioned at the beginning of a milling operation so that the correct point on the ball end of the tool is tangent to the beginning point, and offset perpendicular to the machined edge by the radius of the tool. Consider the example below of milling a ramp in the XZ plane from point B to point C.

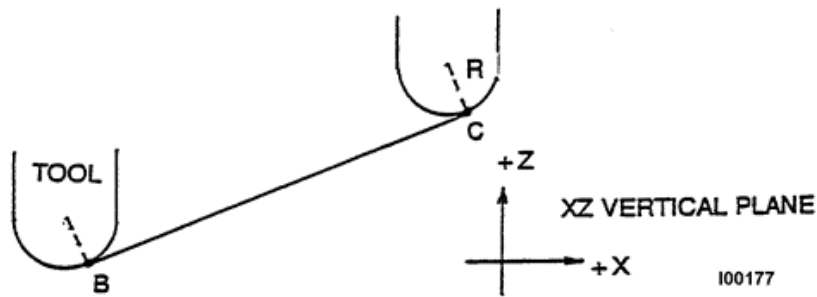

FIGURE 5.8.1 Ball end mill position with respect to program points. Tool starts so end mill is tangent to BC. R from centre of tool is perpendicular to BC

Note how the tool at the beginning point (point B) starts below (in the Z direction) point B so that it can actually touch this point. If this were not true, a cusp would remain to the left of point B.

Now consider a similar example milling from A to B to C in the XZ plane.

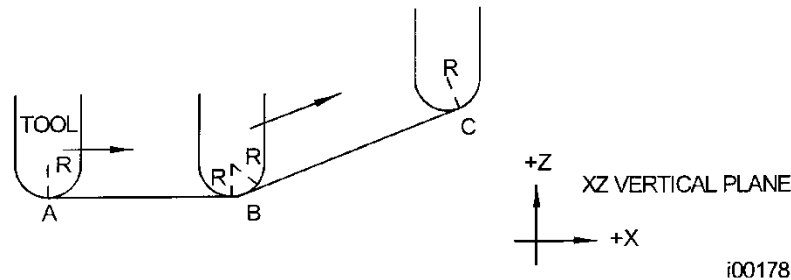

FIGURE 5.8.2 In order to respect the lines defined by the programmed points, the ball end mill never touches point B. Tool starts centred over A offset up by the tool Radius R. It moves right until it is tangent to both AB and BC. Then moves to point C in the first example.

Note the Tool at B does not drop below the AB line and, therefore, never touches point B. As a result, a fillet is formed at point B equal to the tool radius.

This second example of continuous machining from one cut (AB) to another (BC) with full cutter compensation between requires the two cuts to be made with events which are connective (see Section 5.9 or 5.10 for a more complete discussion of this requirement).

5.9 Connective Events

Connective events occur between two milling events (either Mill or Arc) when the X, Y, and Z ending points of the first event are in the same location as the X, Y, and Z starting points of the next event. In addition, the tool offset and tool number of both events must be the same. And both events must lie in the XY plane or the same vertical plane (see Section 5.2).

5.10 Conrad

Conrad is a unique feature of the PROTOTRAK RMX CNC that allows you to program a tangentially connecting radius between connective events, or tangentially connecting radii for the corners of pockets and frames without the necessity of complex calculations.

For the figure below, you program an Arc event from X1, Y1 to X2, Y2 with tool offset left, and another Arc event from X2, Y2 to X3, Y3 also with tool offset left. During the programming of the first Arc event, the system will prompt for Conrad at which time you input the numerical value of the tangentially connecting radius $r=K3$. The system will calculate the tangent points T1 and T2 and direct the tool cutter to move continuously from X1, Y1 through T1, $r=K3$, T2 to X3, Y3.

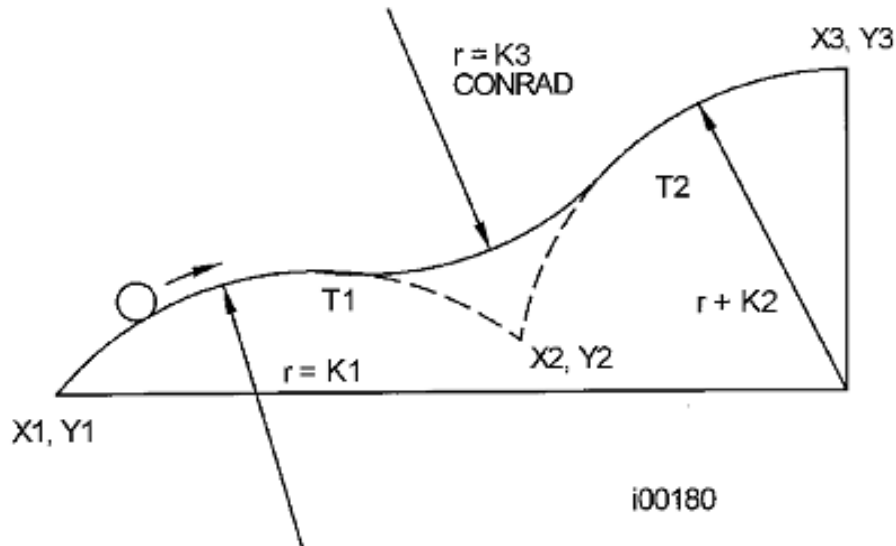

FIGURE 5.10.1 A Conrad is added between the two intersecting lines

Note: Conrad must always be the same as or larger than the tool radius for inside corners. If Conrad is less than the tool radius, and an inside corner is machined, the ProtoTRAK RMX CNC will ignore the Conrad.

For the figure below, you program an Arc event from X1, Z1 to X2, Z2, and a Mill to X3, Z3. During the programming of the Arc event, the system will prompt for Conrad at which time you input the numerical value of the tangentially connecting radius $r=K$. The system will calculate the tangent points T1 and T2 and direct the tool cutter to move continuously from X1, Z1 through T1, $r=k$, T2 and on to X3, Z3.

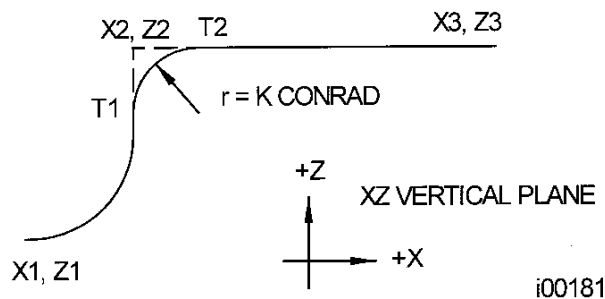

FIGURE 5.10.2 A Conrad is added between an arc and a line

5.11 Memory & Storage

Computers can hold information in two ways. Information can be in **current memory** or in **storage**. Current memory (also known as RAM) is where the ProtoTRAK RMX CNC holds any part program that is ready to run. While a program is being written, it is in current memory.

Storage of programs can be done on a USB device or a Network drive. This means a user can store programs to an offline computer that is networked to the RMX CNC. To add a network drive, the user must setup the operating system to do so. See section 14. We strongly recommend you habitually back up programs.

6.0 Info Keys

Info keys on the left side of the screen enable you to:

- Configure your ProtoTRAK RMX to your preferences
- Make changes to system defaults
- Look up information
- Access advanced capability

Info Keys are always available; while you are doing any operation of the ProtoTRAK RMX you may tap an Info key.

Fly Out Windows

When you tap an Info key, the key will turn yellow and the associated fly out window will appear over the window you had been using. When you are finished with the window, tap the key again to close it.

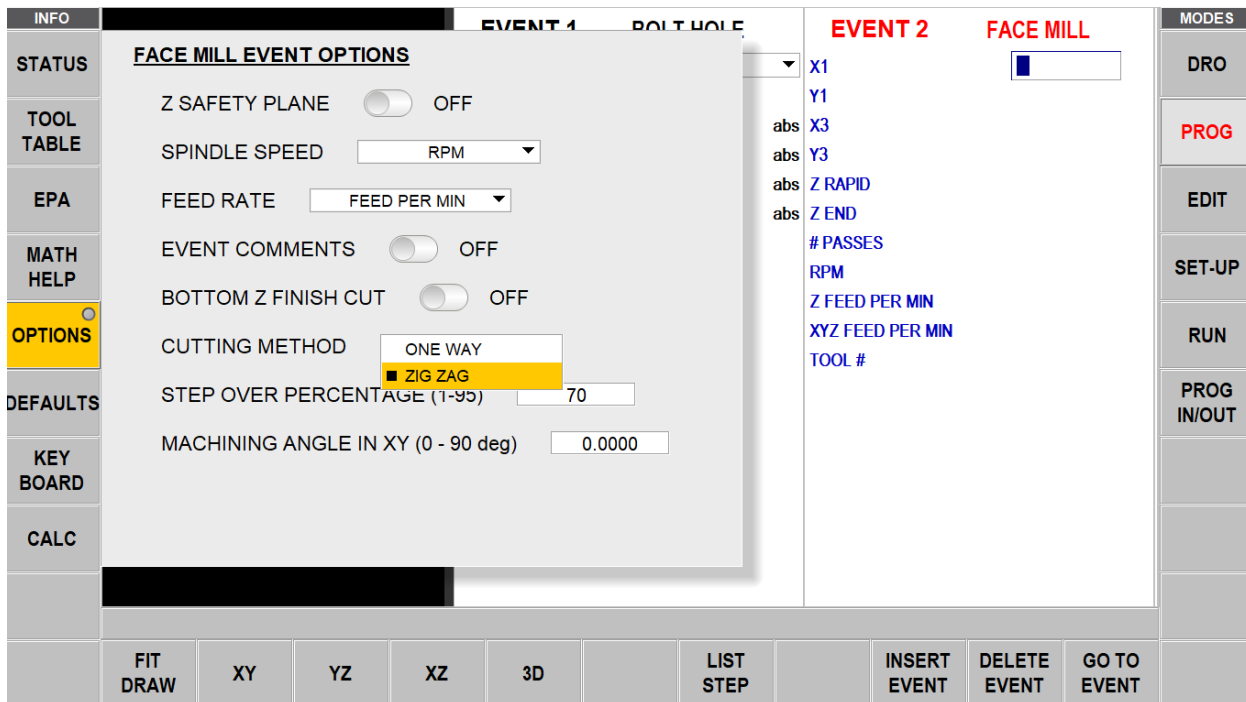

Figure 6a The Option key opens a Fly Out Window over the event programming to give you instant access to relevant choices

Once you open a Fly Out Window, you must close it by tapping the associated Info Key.

INFO	EVENT 6 BOLT HOLE		EVENT 7		TOOL TABLE					MODES	
STATUS										DRO	
TOOL TABLE	LIB #	TOOL #	TOOL TYPE	MATERIAL	# FLUTES	DIAMETER	Z OFFSET	DIA MOD	Z MOD	PROG	
EPA	PROGRAM TOOLS										EDIT
MATH HELP		1	Center Drill	HSS	1	16.000	0.000	0.000	0.000	SET-UP	
		2	Drill	CARBIDE	1	10.000	-10.000	0.000	0.000	RUN	
		3	Face Mill	INSERT	7	80.000	20.000	0.000	0.000	PROG IN/OUT	
		4	Rough End Mill	CARBIDE	4	12.000	1.720	0.000	0.000		
		5	Finish End Mill	CARBIDE	4	8.000	12.342	0.000	0.000		
		6	Tap	HSS	---	8.000	-27.675	0.000	0.000		
DEFAULTS	TOOL LIBRARY										
KEY BOARD	101		Face Mill	INSERT	7	80.000	20.000	0.000	0.000		
	102		Finish End Mill	CARBIDE	4	8.000	12.342	0.000	0.000		
	103		Rough End Mill	CARBIDE	4	12.000	0.000	0.000	0.000		
	104		Rough End Mill	CARBIDE	4	12.000	1.720	0.000	0.000		
CALC			ERASE LIBRARY	CLEAR LIB #	DELETE TOOL	DELETE OFFSET	ADD TO LIBRARY		JOG		
	POSN	DRILL TAP	BOLT HOLE	MILL	ARC	PROFILE	FACE MILL	POCKET	SUB	COPY	MORE

Figure 6b the Tool Table Fly Out makes it quick and easy for you to define your tools as you program

6.1 Status

The Status Info Key gives you a convenient look at the current status of your ProtoTRAK RMX.

6.1.1 Operational Status

Units – chose between In and mm. All dimensional information will appear in the units you choose. If you change units, the change will take effect as soon as you tap the Status key to put the window away.

Axis Mode – from 2 to 3 axis. If you change Axis Mode, the change will take effect as soon as you tap the Status key to put the window away.

Program Name – for reference. You may rename a program in Program In/Out Mode or the Event 0 in the Program Mode.

6.1.2 Software Version

This will list both the current software and firmware.

6.1.3 Options Activated

This is a list of all available control options and whether they are activated. To purchase an option, call XYZ Customer support on 01823 674200

See Section 3.2 for a description of available options.

6.1.4 Features Off/On

Advanced Features – Optional Advanced Features may be turned off if you wish to simplify the operation of the ProtoTRAK RMX by eliminating features.

Network – Access to the networked drives may be turned off so that communications between the ProtoTRAK RMX and the network are halted.

Electronic Handwheels – Electronic Handwheels may be turned off to assure the machine doesn't inadvertently move.

Note: When turned on, the Electronic Handwheels move the table, saddle and head only during DRO Mode and TRAKing® in run mode.

Auxiliary Functions – the AUX event may be turned off if you wish to simplify the operation of the ProtoTRAK RMX.

6.2 Tool Table

The Tool Table is divided into three sections (including the optional Tool Library):

Base Tool

This is the status of the Base or reference tool – Set or Not Set. See below for a description of the Base Reference Tool.

INFO	EVENT 6		BOLT HOLE		EVENT 7		MODES			
STATUS	TOOL TABLE									DRO
TOOL TABLE	LIB #	TOOL #	TOOL TYPE	MATERIAL	# FLUTES	DIAMETER	Z OFFSET	DIA MOD	Z MOD	PROG
							SET			
	PROGRAM TOOLS									
EPA		1	Center Drill	HSS	1	16.000	0.000	0.000	0.000	
		2	Drill	CARBIDE	1	10.000	-10.000	0.000	0.000	EDIT
		3	Face Mill	INSERT	7	80.000	20.000	0.000	0.000	
MATH HELP		4	Rough End Mill	CARBIDE	4	12.000	1.720	0.000	0.000	SET-UP
		5	Finish End Mill	CARBIDE	4	8.000	12.342	0.000	0.000	
		6	Tap	HSS	--	8.000	-27.675	0.000	0.000	RUN
DEFAULTS										
KEY BOARD										
CALC			ERASE LIBRARY	CLEAR LIB #	DELETE TOOL	DELETE OFFSET		ADD TO LIBRARY	JOG	
	POSN	DRILL TAP	BOLT HOLE	MILL	ARC	PROFILE	FACE MILL	POCKET	SUB	COPY MORE

Figure 6.2.1 (a) The Tool Table as it appears without the Advanced Features Option activated.

Program Tools

These are the tools that you have entered into the events of your current program. Up to 100 tools may be entered from 1 – 99.

As long as the tool number is in one of your events, it will automatically appear in this part of the screen. See below for how to set up the tool. You may set up the tool at any time while you are preparing the program, including opening the Tool Table window as you are programming while the tool is on your mind. If you forget to enter diameter or other essential information before running, the ProtoTRAK RMX will present you with an error message. To help, the info that is required before run is highlighted in orange not if entered and it turns green when entered.

Tool Offsets and Mods in Program Tools are **not** saved when a current program is closed, erased or if the control is powered off. To save this information, see Save/Open Temp in the Program In/Out Mode for saving a temporary file.

Tool Library (optional)

When the Advanced Features Option is activated, there will be a Tool Library section in the Tool Table.

The Tool Library can be a convenient way to save tool information and use the information to cut down on time in doing programming and set up. All the information, including the Offsets and Mods, are saved in the Tool Library. You may set up the tools in the Tool Library separately from a program by entering tool information directly into the Tool Library or you may transfer information from Program Tools as you go. Be sure to fully understand the Tool Library procedures to avoid using tools with incorrect or incompatible offsets so you don't crash a tool!

To input information directly into the Tool Library, simply tap in any of the columns of the empty row and enter information.

To transfer tool information that is already in a Program Tool, simply tap on the Program Tool, Tool # and tap ADD TO LIBRARY.

Tool Library tools may be identified by a number from 101 – 199. We do this to distinguish them from the Program Tools which are numbered from 1 – 99.

LIB #	TOOL #	TOOL TYPE	MATERIAL	# FLUTES	DIAMETER	Z OFFSET	DIA MOD	Z MOD
PROGRAM TOOLS								
	1	Center Drill	HSS	1	16.000	0.000	0.000	0.000
	2	Drill	CARBIDE	1	10.000	-10.000	0.000	0.000
	3	Face Mill	INSERT	7	80.000	20.000	0.000	0.000
	4	Rough End Mill	CARBIDE	4	12.000	1.720	0.000	0.000
	5	Finish End Mill	CARBIDE	4	8.000	12.342	0.000	0.000
	6	Tap	HSS	—	8.000	-27.675	0.000	0.000
TOOL LIBRARY								
101		Face Mill	INSERT	7	80.000	20.000	0.000	0.000
102		Finish End Mill	CARBIDE	4	8.000	12.342	0.000	0.000
103		Rough End Mill	CARBIDE	4	12.000	0.000	0.000	0.000
104		Rough End Mill	CARBIDE	4	12.000	1.720	0.000	0.000

Figure 6.2.1 (b) The Tool Table with the Advanced Features Option activated. See Section 6.2.4 below for using the Tools from the Tool Library.

Tool Table Column Headings

LIB# - Used only in the Tool Library section. You assign numbers to the tools in the Tool Library by tapping this field. In order to distinguish Tool Library from tool numbers you assign during programming, the Tool Library tools must be a number from 101 – 199. It is not mandatory to assign a Library Number, but it may

help as a cross reference when you assign the Library tool to a Program Tool. If you want to use the library tool in DRO, then a library tool number is required.

Tool # - the tool number you assigned in the current program, from 1 – 99. These tools are the Program Tools.

Tool Type - the type of tool chosen from the drop down list if you elect to do so.

Material - selects the tool material from the drop down list if you elect to do so.

Flutes - specifies the number of flutes for the cutter. This is elective unless you use Feed per Tooth.

Diameter - the tool diameter. This is mandatory in order for the ProtoTRAK RMX to calculate the tool path with offsets.

Z Offset – the difference between this tool and the Base Tool. You must set this tool to run the program. The field will be orange and there will be a line instead of a number until the tool is set.

Dia Mod - allows for small adjustments e.g. for reground tools; this is elective.

Z Mod - allows for small adjustments in Z Offset; this is elective.

6.2.1 The Base Tool

For your convenience, we suggest you create a “base” tool. This is something such as a cutter inverted in a collet chuck, piece of ground bar in a collet chuck or an electronic edge finder. Referencing all tool offsets from this Base Tool gives you the ability to use the same tools in several programs without resetting offsets. We also suggest that you establish a point you will use to touch off every time such as a piece of bar sitting on the machine bed or a height setting gauge mounted on the machine table. This simple habit will make tool setting quick, easy and secure.

Each time the ProtoTRAK RMX is powered down, you will need to reset the Base tool (the ProtoTRAK RMX can't be sure that the spindle wasn't moved while the power was off).

6.2.2 Setting Z Offsets

Setting Z Offsets is simply a matter of first setting the Base Tool and then each tool. You can tell if a tool is not set because the box will be orange and there will be dash instead of a number.

To Set the Base Tool:

1. Put your Base Tool in the spindle.
2. Tap the Z Offset box in the Base Tool part of the Tool Table screen.
3. Touch off your Base Tool. We recommend that you use a touch-off point that you will be able to use for all tools, now and in the future. If you mix up touch off points, you will crash a tool.
4. Press Enter.

Set the other tools Program or Tool Library:

1. Put the tool in the spindle.
2. Tap the Z Offset box for the tool.
3. Touch off the tool to the same place that you touched off the Base Tool.
4. Press SET
5. Repeat for all tools that you want to set or reset.

Note: Just because the field offset field is green and there is a number instead of a dash, this is NOT a guarantee that the offset is correct. If you want to start over to be sure, tap the value and tap the DELETE OFFSET key and redo the offset with the procedure above.

6.2.3 Using Library Tools while programming.

The Flyout Windows of the ProtoTRAK RMX makes programming your tools easier than ever. At any time, tap the Tool Table key and the window will open over the mode window you are working in. Having a Tool Library at hand makes it even easier.

To use the Library Tools, simply do the following:

1. While programming, enter a number for your Program Tool from 1 – 99. This will create an entry in the Program Tools area of the Tool Table for each unique tool number. The entry will appear as soon as you finish all the prompts for the event.
2. Tap the TOOL TABLE Info key. The Tool Table will open.
3. In the Tool Library section of the Tool Table, tap the Tool # Field in the row of the Library Tool you want to use.
4. Press Enter. The information for the tool in the Tool Library will copy to the Program Tool. If the Library Tool had a LIB #, that number will appear for reference next to the Program Tool #.

That's it!

Note: *we do not allow you to enter the Library Tool # into the Tool prompt while programming an event. We do this as a precaution. Tool Library Z Offsets are stored in the control, but that doesn't mean they are correct. Programs written at different times, on different ProtoTRAKs or on the Offline Software may have offsets stored that are not correct for the machine and tool on which they will run.*

To prevent errors, we make it a deliberate action for you to relate the Library Tool to the Program Tool. This will give you the chance to decide whether you want to trust the values or not. It is an extra step, albeit a small one, but well worth it to avoid what could be an expensive crash.

6.2.4 Soft keys in the Tool Table

ERASE LIBRARY (option) – To erase all the Library Tool information at once.

CLEAR LIB# (option) - To erase the Library Tool # reference from the Program Tool. First tap the Program Tool #, and then CLEAR LIB#.

DELETE TOOL (option) – deletes the data for a Library Tool. Tap anywhere on row first, then tap DELETE TOOL.

DELETE OFFSET – deletes the offset for the tool. Tap anywhere on the row first, then tap DELETE OFFSET.

ADD TO LIBRARY (option) – copies the Program Tool information to the Tool Library.

JOG – turns on the servo motors so you can jog the head to position for doing the Z offset.

Note – the jog feature always defaults to the positive direction.

(option) – These soft keys pertain to the Tool Library. The Advanced Features Option must be activated for the Tool Library to be available. If the keys are greyed out, the Advanced Features Option is not activated.

6.3 EPA

The EPA (Enhanced ProtoTRAK Assistance) key will give you quick access to a collection of short tutorials that provide help for using the ProtoTRAK RMX CNC. While these tutorials are useful for resolving questions or jogging the memory, they are not intended to substitute for the user manual or for product training.

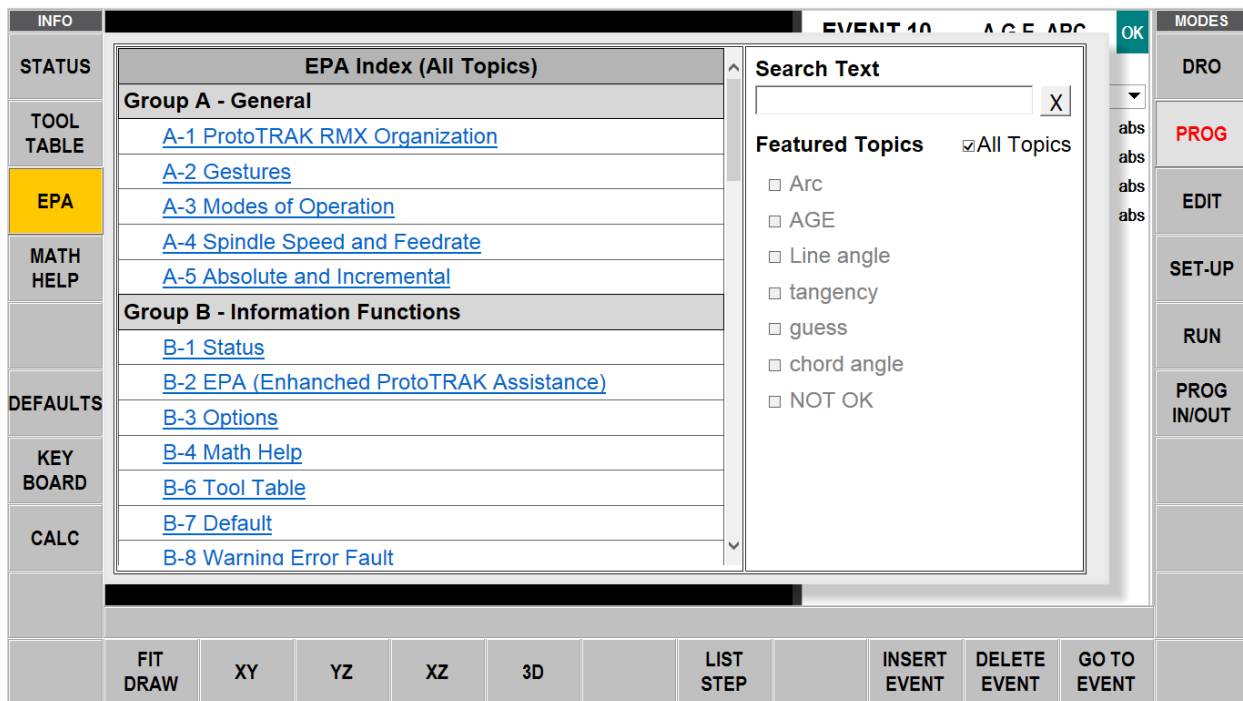

Figure 6.3 The EPA Screen

6.3.1 EPA Index

The EPA Index will display the tutorials available depending on either the current operation or your selection in the Search Text box.

For example, if you are in the Program Mode, when you press the EPA key, the EPA Index will display the topics most likely to be of interest for Program Mode operations. For example, say you are doing a part program using the AGE (Auto Geometry Engine™) and you forget the meaning of the Line Angle prompt. By pressing the EPA Info key, the EPA Index will appear. Instead of listing all the topics, a shortened list of only those topics likely to be of interest for that operation will appear so you will be able to quickly choose a tutorial with the information you need.

EPA Topics are arranged in Groups:

- A. General – overall operation of the ProtoTRAK RMX
- B. Information key
- C. DRO Mode
- D. Program Events
- E. Other Program Features
- F. Edit Mode
- G. Set-up Mode
- H. Run Mode
- I. Program In/Out

6.3.2 Searching the EPA Index

There are two ways to search for topics:

1. Enter a key word into the Search Text box. (See section 6.8 Keyboard). Only the applicable tutorials will appear in the EPA Index box. If you don't like the results, try a different word. To clear previously entered text, tap the X to the right of the Search Text box.
2. Select a Featured Topic from the list by tapping the topic word. A check mark will appear to indicate that the selection is successful. Selecting All Topics will display the full list of topics arranged by groups. To deselect, box again.

6.3.3 Navigating through a Topic

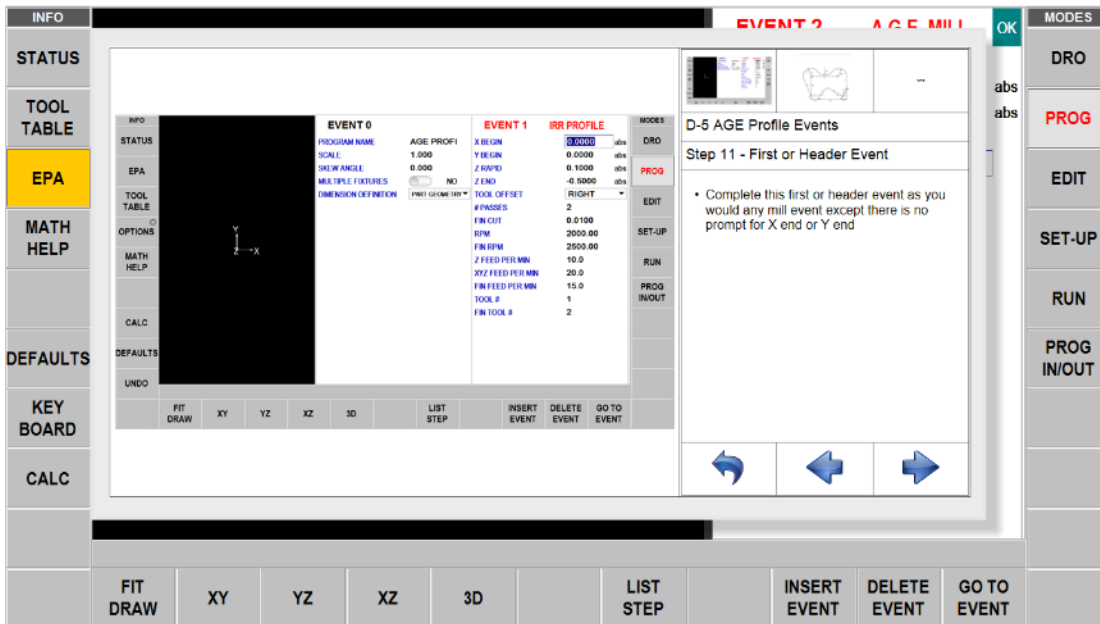

Figure 6.3.3 An EPA topics screen

Display area – the EPA will display helpful graphics, screen shots or videos as required to help explain the topic. It will be blank if the text does not need illustration.

Items available – sometimes there are more than one display available for the topic. Tap the one you want to display.

Use the arrow keys to move through the instructions or to return to the index.

6.4 Math Help

Math Helps are powerful routines that enable you to use data that you have available in order to calculate missing X and Y beginning, ends and centres. The powerful Auto Geometry Engine™ feature will automatically calculate missing print data in most cases, Math Helps provide a powerful companion to that feature.

You may enter into Math Help at any time by pressing the Math Help Info key.

The calculated data may be automatically loaded into your program by entering Math Help while you are programming a beginning, end or centre.

6.4.1 Example – using Math Help 17

By studying the print in the drawing below, we observe that the drawing lacks the call out for the tangent point between the line and the arc.

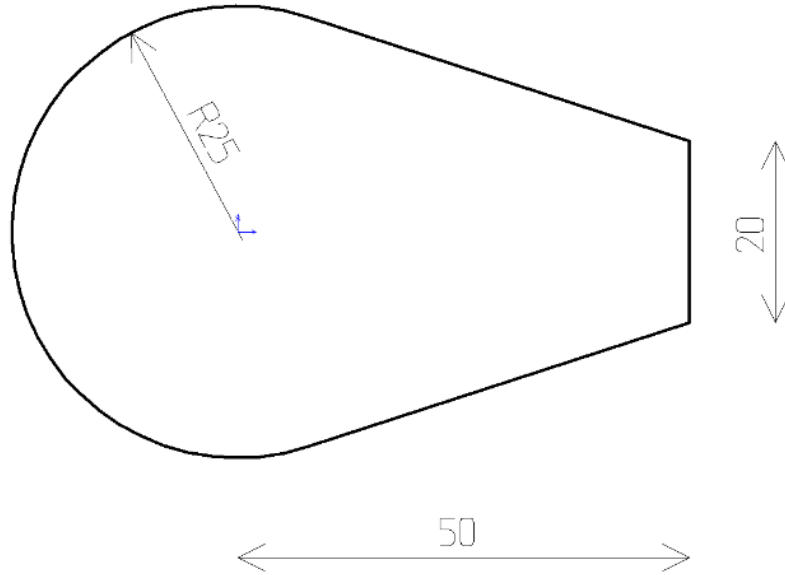

The first screen you will encounter after pressing the Math Help info key will be show you the groups of Math Helps.

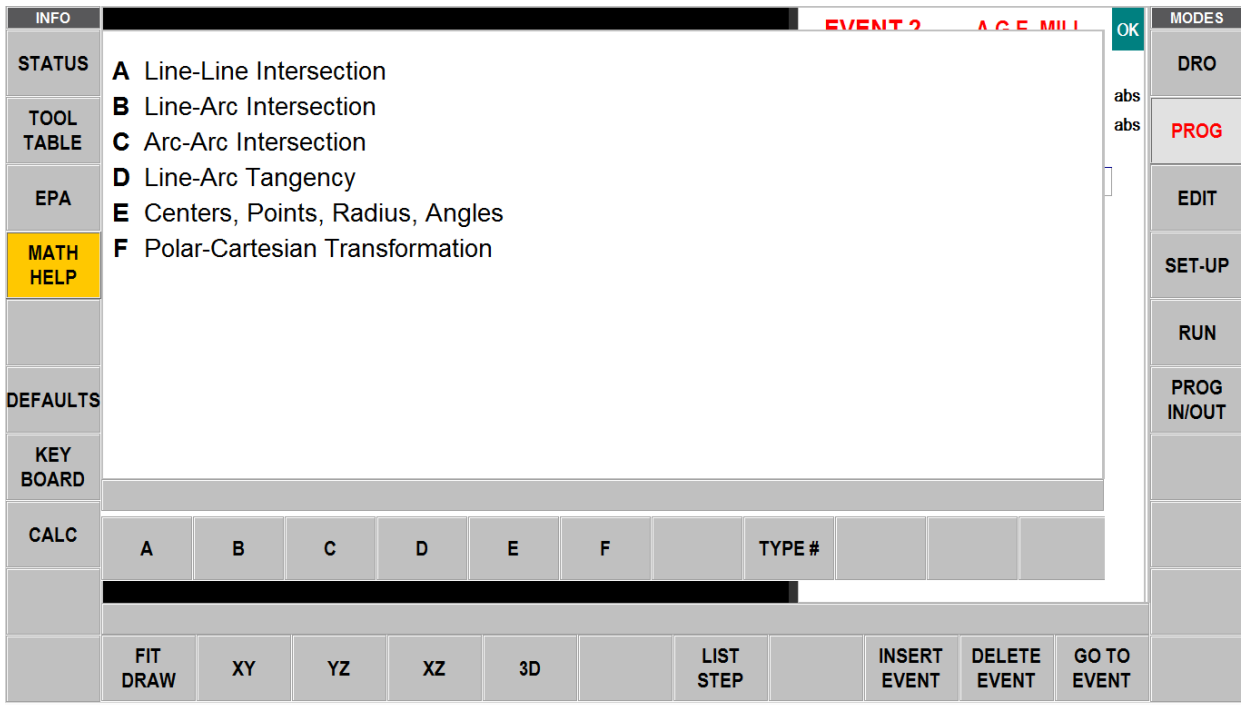

If you already know that you want a particular Math Help, tap the TYPE # key and enter the number. In the example above we see that we want to know a point tangent to the line and arc on the drawing. We select Group D Line-Arc Tangency by tapping the D key. Then we get the following choices:

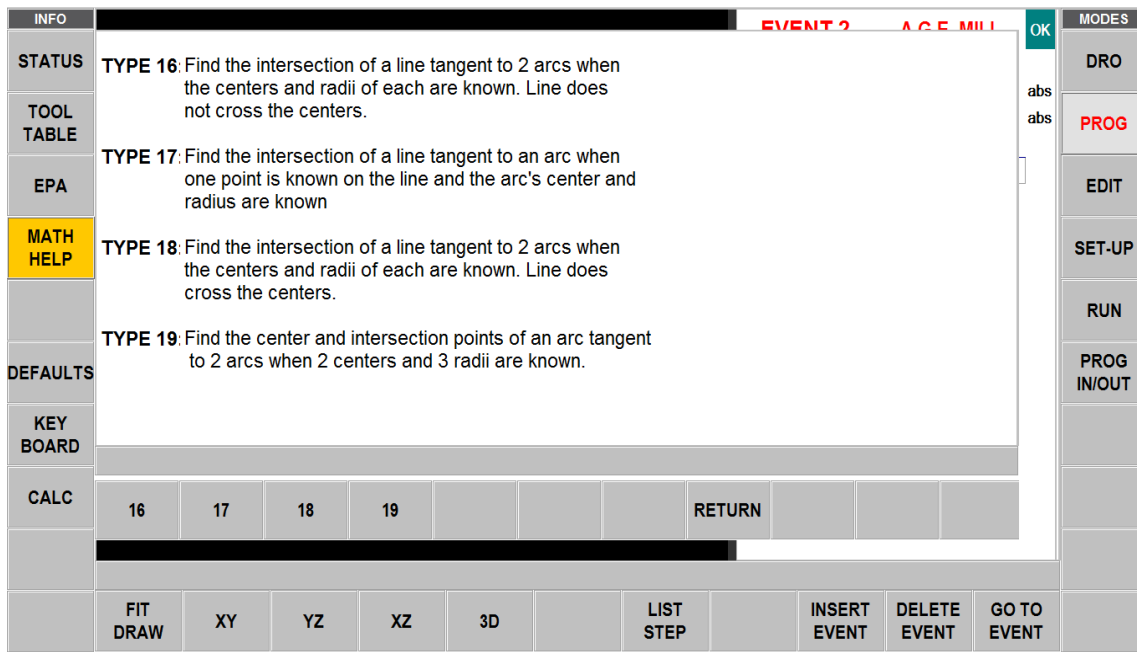

Further study of the print reveals that we have the information most suitable for Math Help 17. We select 17 by tapping the 17 key.

Enter the known print data as prompted on the data input line. Unlike the event programming, you must enter the data on the data input line near the bottom of the screen. You cannot type the data directly into the list of data as you can in other places in the ProtoTRAK RMX. Use the DATA UP and DATA DOWN keys to move through the list of data.

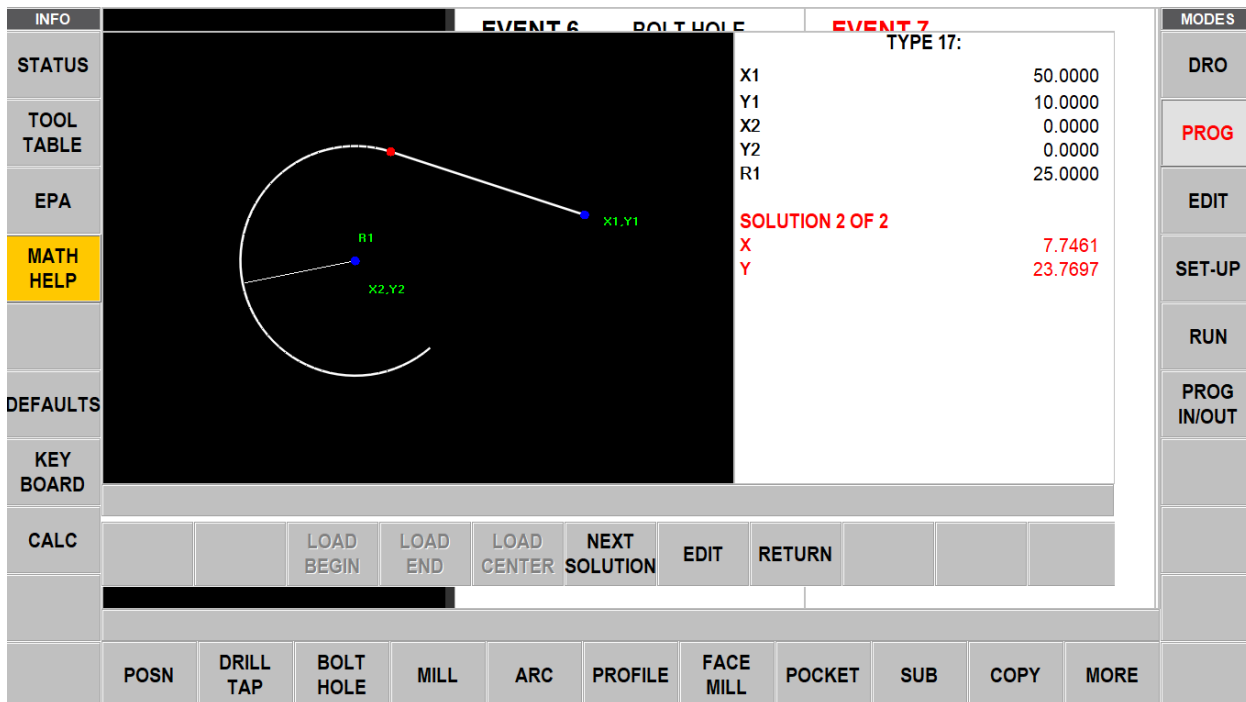

Figure 6.4.1 Math Type 17 gives us two possible solutions.

There are two theoretical solutions to this problem. The ProtoTRAK RMX will display them in turn. Tap NEXT SOLUTION to look at the alternatives. Looking at the print, you can easily see that we want Solution 1.

If the drawing reveals that you have made a mistake in the data, you may edit your inputs on this screen by tapping Edit. After you correct or change the entry, tap RE-SOLVE.

If you wish to input these values into the program, first tap the number you want and then tap the Load Begin, Load End or Load Centre. If you are not in the Program Mode, the Load keys will be greyed out.

6.5 Defaults

Defaults make programming easier by customizing the ProtoTRAK RMX to your machining style and the type of work you are doing. For example, if you usually work in aluminum, you can set your Default Step-over percentage to a larger number so that pockets and face milling events will take less time to run. If you usually work in tool steel, you would set a Step-over percentage to the much lower number appropriate for that work.

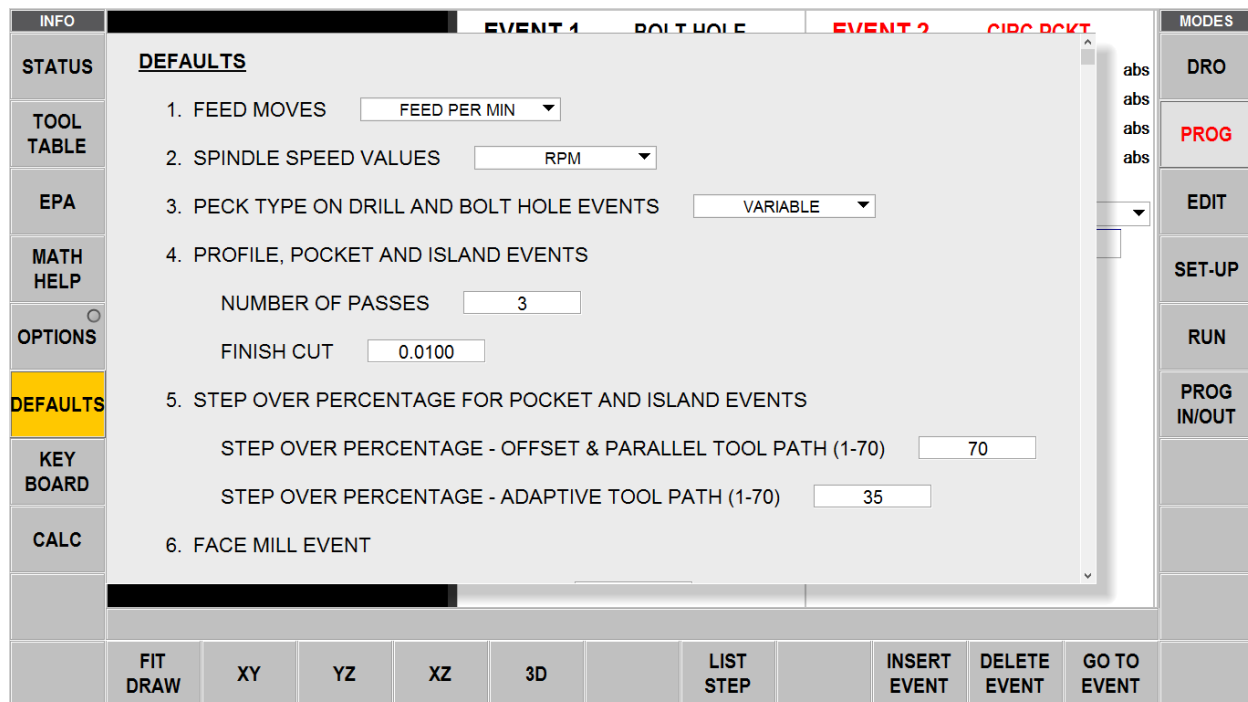

Figure 6.5 The Defaults Flyout Window.

6.5.1 Default entries and what they mean.

The following are the Default values that you may enter. The number corresponds to the number on the Defaults Flyout Window.

1. Feed Moves:

Feed per Min – the Feedrate in Inch per minute or mm per minute.

Feed per Tooth – the Feedrate in inch or mm per tooth. The number of flutes must be defined for the tool in the Tool Table.

Math Help Type 30 will calculate IPM from the RPM, inch/tooth and number of teeth values you enter

2. Spindle Speed Values

RPM – Spindle speed in Revolutions per Minute

SFM or SMM - Surface Speed in Surface Feet per Minute or Surface Metres per Minute, which is the speed of the outside Diameter of the tool.

Math Help Type 31 will convert an RPM value to SFM or SMM.

3. Peck Type on Drill and Bolt Hole events

Variable – progressively less each peck with full retract out of hole on each peck

Fixed – same depth each peck with full retract out of hole on each peck

Chip break – retracts 0.5mm between pecks. The pecks are the same as Fixed.

4. Profile, Pocket and Island Events

Number of Passes – the total Z cut divided evenly by this number.

Finish cut in X / Y – the amount of wall material for the finish cut.

5. Step over percentage for Pocket and Island Events.

Step over percentage is the percentage of the tool diameter overlap as successive material is removed.

Step over percentage – Offset and parallel tool path – this step over percentage should balance the speed of the cut, working the tool properly, and the fact that the cutter will be loaded up more on the initial cut where it will be taking a full width of cut, and when it is in a corner.

Step over percentage – Adaptive tool path (Advanced Features Option). Adaptive tool path is a complex software routine to achieve all cutting at a constant chip load. This enables you to determine the chip load by the combination of other settings and the ProtoTRAK RMX will automatically calculate the tool path needed to obtain the finished part using that chip load.

6. Face Mill Event

Step over percentage – the percentage of tool diameter overlap as successive material is removed.

Cutting method:

- One Way - all machining is in one direction with rapid positioning in between. This enables you to have all climb or conventional cutting for the entire event.
- Zig Zag – the machining is in a back-and-forth pattern, with no rapid positioning between changes of direction. This has the effect of alternate climb and conventional cutting.

Z Finish cut – while programming the event, you will only see the prompt, and the default value set here, when the Bottom Finish Cut is set to 'Yes' in Options.

7. Pocket and Island events

Cutting Direction:

- 1 – CW – Clockwise (conventional cutting)
- 2 – CCW – Counterclockwise (climb cutting)

Z Entry method:

- Plunge – Z goes straight down at the Z Feedrate programmed.
- Helical – the X, Y and Z are automatically programmed to feed into the part in a helical motion.
- Zig Zag – the Z feeds in a back-and-forth motion.

Tool path pattern:

- Offset - Starts in a logical place depending on the part geometry and takes successive passes based on the Step over percentage.
- Parallel – Starts in a logical place and will move in parallel lines depending on the part geometry. Moves back and forth in successive passes. In Machining Angle below, you can enter in an angle for the parallel moves if the part feature is not aligned to the X axis.
- Adaptive (Advanced Features Option) – Complex software routine that maintains a constant chip load as it is cutting.

Adaptive Tool Path allows you to machine much faster than other tool paths. With other types of tool path, you must limit your feed rate and step over percentages to those cuts where the tool will be loaded the most. A common example of an area with the greatest chip load is the corner of a pocket. That means that the rest of the tool path is cutting at feeds much lower than the cutter could take.

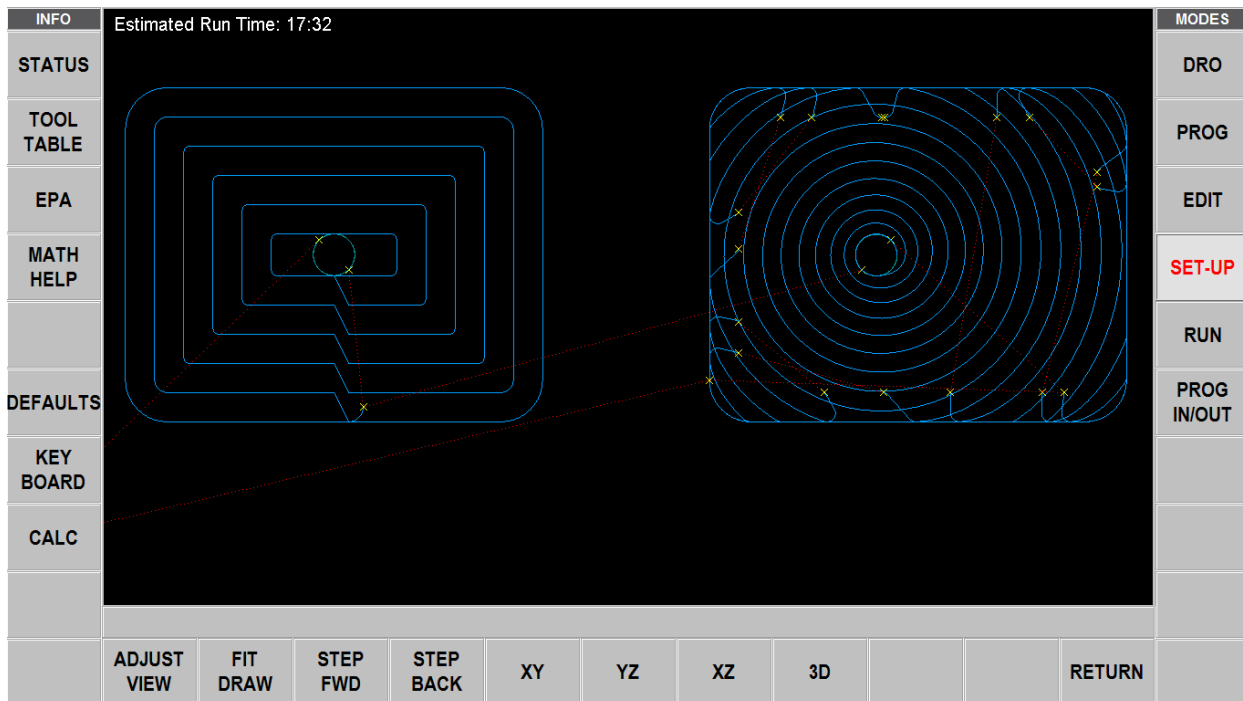

Figure 6.5.1 (7) Offset tool path on the left, Adaptive on the right.

Adaptive Machining is powerful software that calculates a tool path to keep the chip load constant. You can set step over percentages and feedrates more aggressively and it is the job of Adaptive Tool Path to move along a toolpath that won't overload the tool.

Cutting Method:

- One Way - all machining is in one direction with rapid positioning in between. This enables you to have all climb or conventional cutting for the entire event.
- Zig Zag – the machining is in a back-and-forth pattern, with no rapid positioning between changes of direction. This has the effect of alternate climb and conventional cutting.

Z Finish cut – while programming the event, you will only see the prompt, and the default value set here, when the Bottom Finish Cut is set to 'Yes' in Options.

Helical Entry Pitch – input the pitch of the Helix used when starting a pocket.

Zig Zag Entry Angle - input the angle of the back and forth motion used in starting a pocket

Machining Angle – this is only needed when Toolpath Pattern (above) is set to Parallel. It is useful when the part or the pocket is not aligned with the X axis. The Machining Angle allows you to have a toolpath that better suits the part.

Order of Passes – this is the strategy for when the pocket cannot be completed in a complete pass without picking up the tool. For example a roughing tool is used that cannot fit in the entire pocket in one continuous path. You have these choices:

- Depth – completes each depth for all regions before moving to the next depth. In other words, completes each pass for each region.
- Region – completes all passes in each region before picking up the tool. In other words, the part is machined to final depth in each region before starting the next region.

Roughing Link for Rapid – this works with the Adaptive Toolpath Pattern. When optimizing tool load, the toolpath is not always contiguous, sometimes the tool needs to move from where it is in to a different section. Those moves between sections are called links. As a default, the ProtoTRAK RMX will handle links in this way:

- For a rectangular pocket it will lift the tool to Z rapid and move at rapid to the next section and rapid down to 0.5mm above pass depth and then feed to the final depth.

- For an irregular pocket, it will lift the tool to Z Rapid (or the Z Safety Plane), then move at rapid to the next section and rapid down to 0.5mm above pass depth and then feed to the final depth.

If you do not care that the tool stays into the cut between sections on the rough cut, you would enter a small value into this prompt. If the links are large, the part may be machined more quickly by having a rapid move between sections. The next prompt will allow you to preserve your finish at the bottom of the cut.

Note: in Figure 6.5.1 (7) above, the link length is set to a small value, hence the many rapid moves.

Bottom Z Finish link length for Rapid – This default works with Adaptive Toolpath Pattern and is applied when the Bottom Z Finish Cut is set to ON in Options. You may want to minimize the tool marks that occur when the tool lifts from the cut and then reenters. To keep the cutter down into the part, enter a value here that is big enough to include your largest Link length.

Minimum Curvature Radius – This value works with the Adaptive Tool Pattern. In order to keep the load constant on the tool, the Adaptive Toolpath often moves along a series of arcs. The Adaptive Toolpath will try to fit into any section where the tool fits. This could result in the toolpath whittling away at a narrow area that would be better left for a finishing tool of a smaller radius. The Minimum Curvature Radius allows you to set a minimum radius of the arcs to preserve more Rest area for a smaller tool.

Note: Rest area is simply the material that is left over from the rough cut, that is, the "rest" of the material. Apparently someone got a patent on the use of the word "residual".

Cut Tolerances are the tolerances that are used when calculating a toolpath. Depending on the complexity of the geometry the calculated toolpath that the machine will follow could deviate by these amounts. These are not machine tolerances.

These tolerances are applied to Parallel and Adaptive toolpaths. For Offset toolpaths the typical accuracy of the calculations should be $\sim 1e-6$. For most parts such as circles, rectangles and non-complex geometry there should be little to no deviation and the calculated toolpath is extremely accurate. All Semi-Finish and Finish passes should have the same $\sim 1e-6$ accuracy when calculating the toolpaths.

Rough Cut Tolerance – With Finish Cut – This is the amount of deviation that is allowed from the calculated roughing toolpath. The roughing toolpath is the programmed part minus the finish cut amount minus the cut tolerance. A larger tolerance allows the ProtoTRAK RMX control to calculate the tool path faster, but with the possibility of having larger scallops that would be cleaned up automatically with the Semi-Finish pass. Lowering this value will increase the time to calculate the tool path but also may allow a tool to fit into tighter areas and allow the rough tool to remove more material before the REST tool comes in to finish the remaining material. Depending on the shape and complexity of the part, the rough cut dimension could vary from the programmed dimension minus the finish cut amount to the programmed dimension minus the finish cut amount minus 2 times the cut tolerance. You are guaranteed that the rough cut will never enter the finish cut material.

Rough Cut Tolerance – With No Finish Cut – The concept is the same as above, but a smaller tolerance should be entered since this value is only applied when you are machining a pocket or island with no finish cut. This ensures the pocket will be machined accurate to within this tolerance.

Rest Cut Tolerance – Machining REST material is the same as the ROUGH CUT TOLERANCE – WITH FINISH CUT. Since you will use the same tool for removing REST material as for finish cuts, this setting allows you to machine faster until the toolpath transitions to the Finish Cut.

8. Subroutine and Copy Events

These defaults are handy for people who use subroutines events in standard ways. For example, using subroutines to repeat programmed events for Finish Cuts. You will be able to override the default value at the subroutine prompts.

Percent speed – origin event(s) Spindle Speed times this value.

Percent feed – origin event(s) Feedrate times this value.

Mirror direction:

- Forward – the toolpath will be mirrored and therefore will be the opposite of the toolpath of the origin event(s).
- Backward – the toolpath will not be mirrored and will maintain the same climb or conventional direction as the origin event(s).

9. Reference Positions

Limits – allow you to set default software limits that are relative to the X, Y and Z Absolute values you set. The ProtoTRAK RMX will not go past these limits.

Home position – In Run Mode, the ProtoTRAK RMX will return to these positions. These numbers are relative to the Absolute 0 set in DRO Mode.

10. Units Inch/mm

Setting the default will have the ProtoTRAK RMX operate in that unit each time it is turned on.

Note: You may change your current operations from one unit to the other with the Status Info key.

11. Start up in 2 or 3 Axis Mode

This default determines how the ProtoTRAK RMX starts after being powered down. You can change this in the Status info key.

12. Maximum Rapid Feedrates

If you do not want the maximum of 10160mm per minute you can set the maximum here. Note – the Z axis runs at 6350mm per minute.

13. Accessory On Button

This will determine what the Accessory Button will control. You may have both hooked up to the ProtoTRAK RMX and move from one to the other.

Coolant – signal to coolant

Mist – signal to mister (not used on Euro machines)

14. Tool Compensation

- Centre – no tool compensation, the tool will move along the programmed toolpath
- Right – the tool moves to the right of the programmed toolpath, offset by the radius of the tool diameter set in the Tool Table.
- Left – the tool moves to the left of the programmed toolpath, offset by the radius of the tool diameter set in the Tool Table

Note: see Section 5.7 for a nice illustration of Tool Diameter Compensation.

6.5.2 Working with Defaults

As you are programming, press INC SET or ABS SET to accept the default value, or simply enter another value and press SET.

Whatever you choose as a default can be easily changed in defaults or overridden event by event with the prompt or in the Options Flyout window.

If you change Default value in the middle of the program, the new Default value will take effect on the Event you are on when you make the change. For example, say you have the Default value TOOL PATH PATTERN set to ADAPTIVE from Event 1 to Event 5. While programming Event 6, you change the Default from ADAPTIVE to OFFSET. The Adaptive tool path would apply to Events 1 – 5 and the Offset tool path would apply to Event 6 and thereafter.

The following are some practical examples of how to use Default values.

1. Step Over Percentage – Adaptive toolpath set to 30% of the cutter diameter

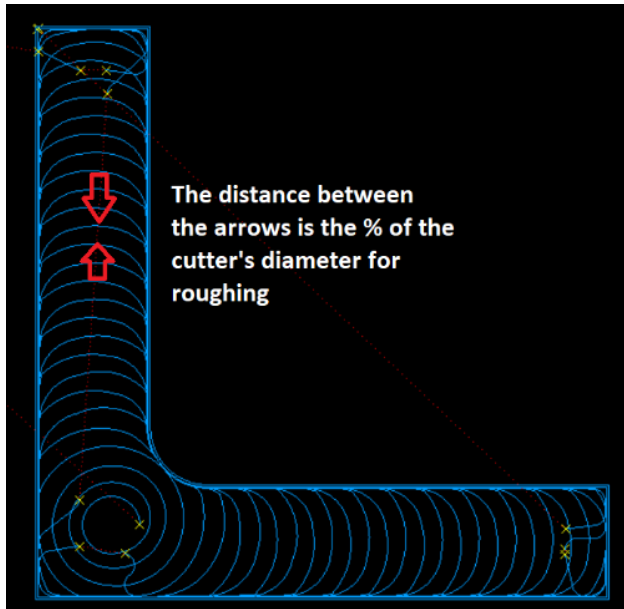

This illustration is the adaptive roughing strategy for a 12mm diameter tool at 30% step over. That means the width of cut (step-over) per circular cutting pass is only 3.6mm but the depth of cut is 12.5mm. The feed rate can be 7366 mm / min @ 5000 RPM, resulting a larger amount of material being removed with less spindle power.

2. Cutting Direction:

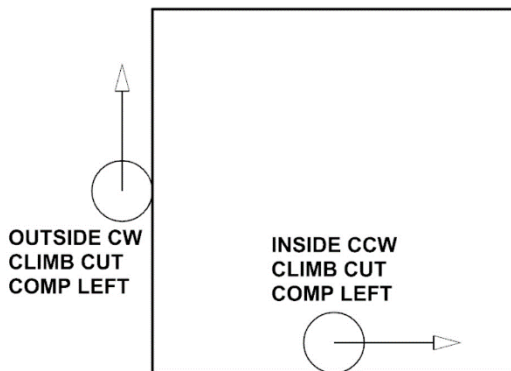

Pockets:

Set to 1- CW to conventional cut

Set to 2- CCW to climb cut

Profiles:

Set to 1- CW to climb cut

Set to 2- CCW to conventional cut

3. Z Entry Method - Helical

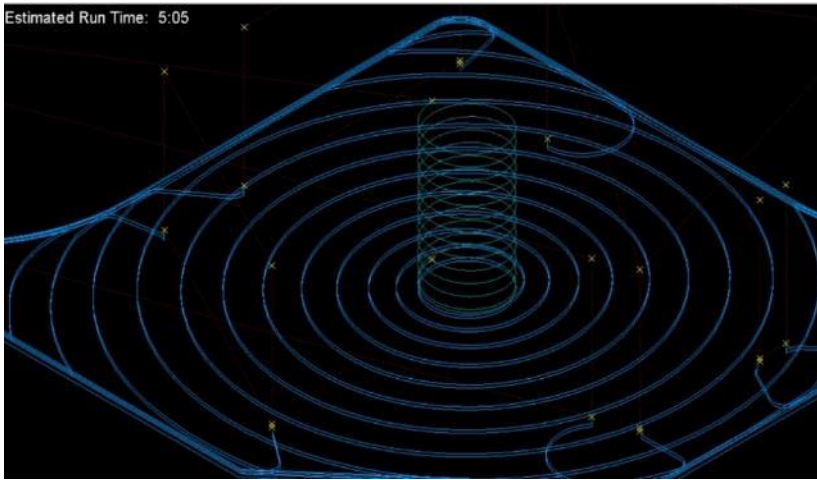

By setting your Z entry type to helical, you can often get to the Z cutting depth faster. For instance, a 12mm diameter cutter in aluminum using a helix entry, with a pitch of 1mm, can run at 4000 RPM and a feed of 1600mm per minute. This can be done with the same tool you use to rough with so there is no tool change required.

4. Default Toolpath Pattern - Adaptive

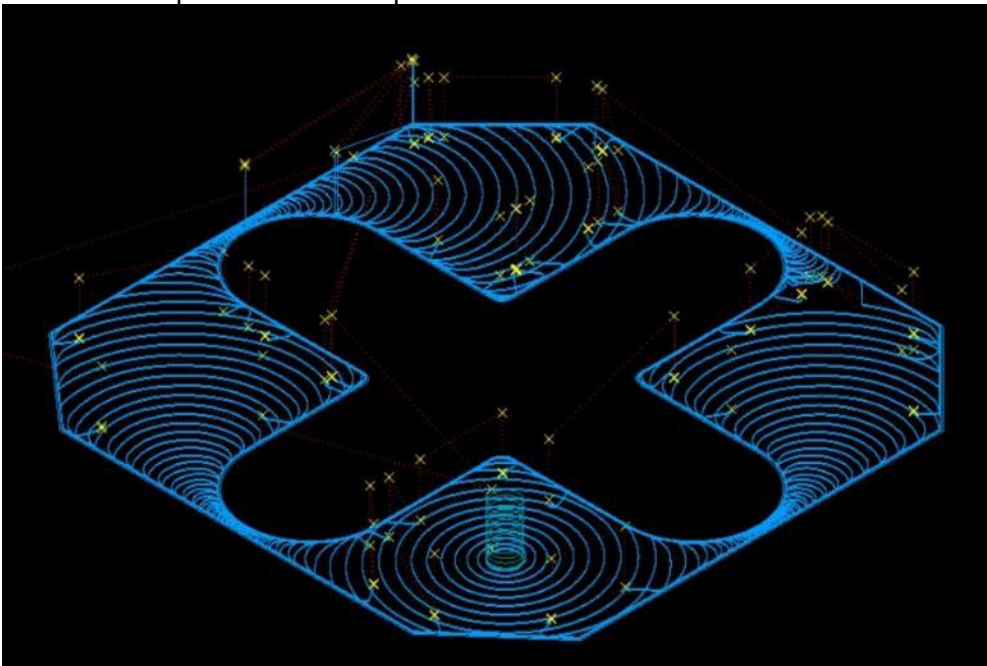

Adaptive roughing is the fastest method of stock removal, with the least amount of wear and tear on both the tool and the machine. Notice the sweeping arc movements. This cutting strategy is extremely efficient.

5. Default adaptive cutting pattern set to Zig-Zag

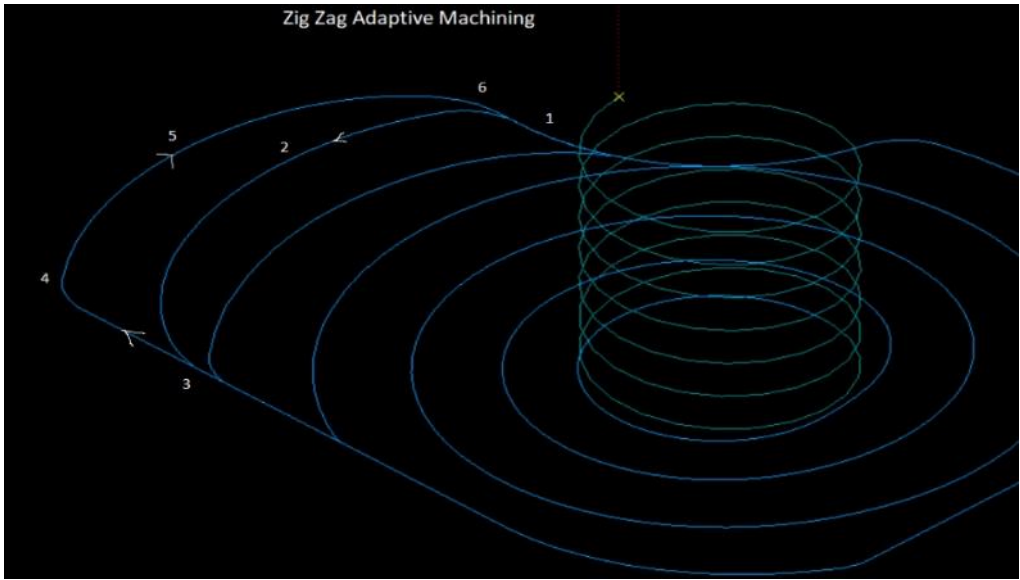

This picture illustrates Adaptive Zig Zag roughing strategy. By combining climb and conventional cutting, the tool will stay down and in the cut and require fewer moves to reposition.

6. Helical Pitch Entry

The helical entry pitch has a strong bearing on how fast you can feed your tool down to the required Z depth. The smaller the pitch, the faster the feedrate. We recommend you start with a 1mm pitch for softer materials and half of that for harder materials.

7. Order of Passes

By Depth:

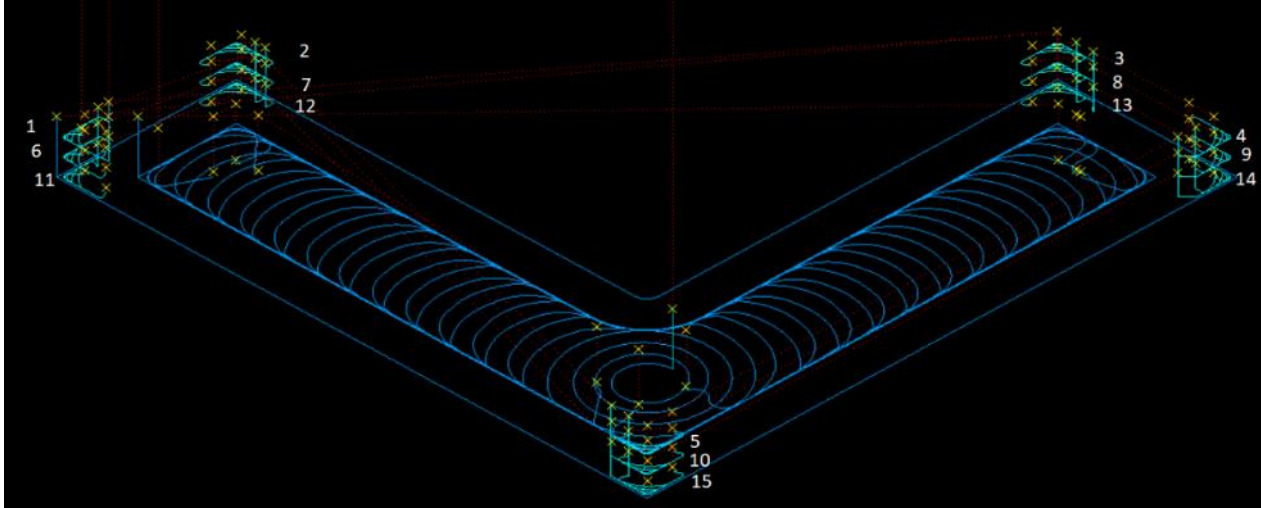

All roughing and rest cuts are made a one Z level before proceeding to the next Z level, as shown in this illustration. Notice how the tool moves to all 5 regions at each Z depth. This makes a total of 14 rapid moves.

By Region:

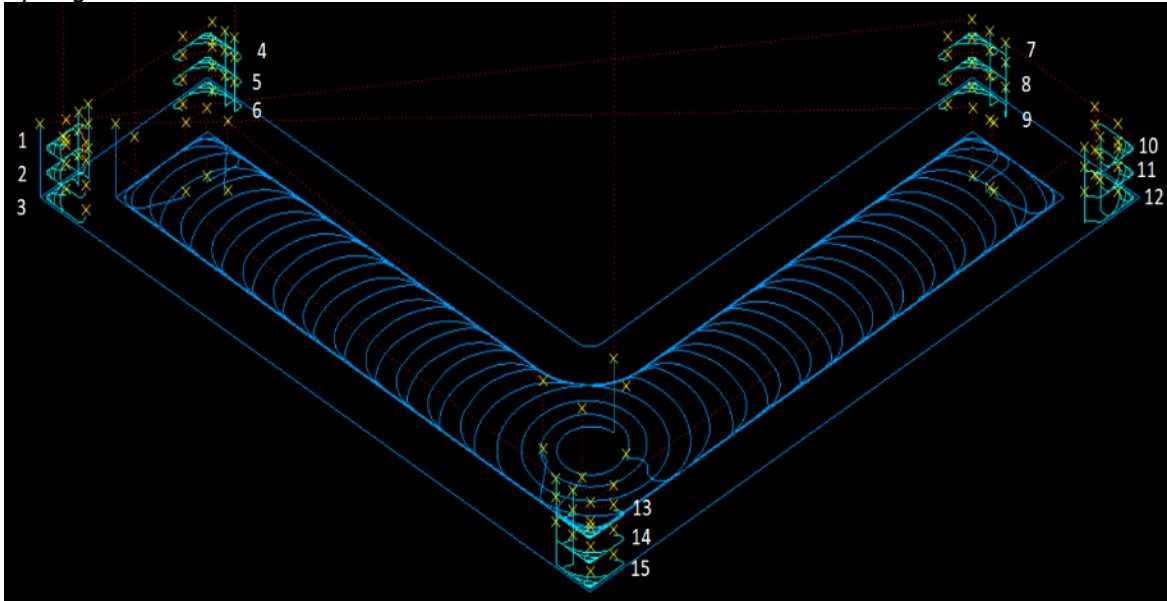

All Z roughing and rest cuts are made in one Z region before proceeding to the next region, as shown in this illustration. This strategy makes a total of only 5 rapid moves. There is minimum of traverse-wasting time. Notice cuts 1,2 and 3 are all in the same corner. The other corners are the same.

8. Minimum Curvature Radius

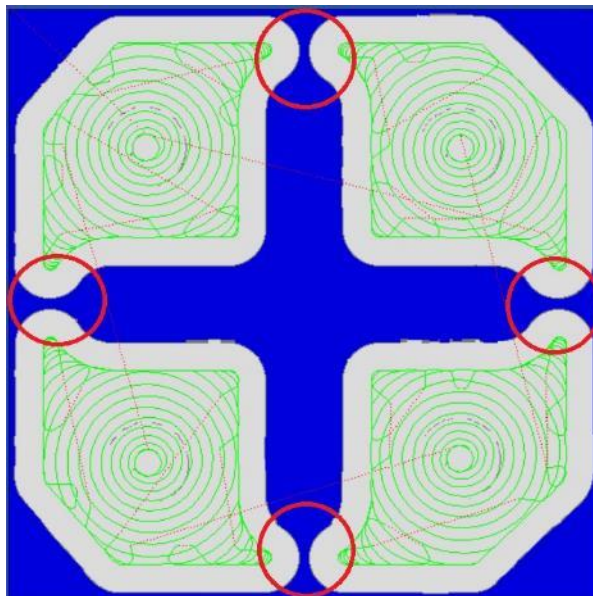

Above is a part cut with the standard minimum curvature radius of 2.5mm, utilizing a 12mm cutter. Notice the areas circled. The cutter could not fit the toolpath between the pocket and the island. This leaves a large amount of stock that the tool will have to cut through at full depth and full width of cut. At high feeds, this may damage the cutter.

Below the minimum curvature radius was changed from 2.5mm to 0.25mm. The toolpath can now fit between the pocket and the island. This slight adjustment allows the use of the larger 12mm cutter to do the heavy machining you would want to accomplish with the largest cutter diameter possible. Your maximum feed rate will have to decrease but the cycle time will be faster overall.

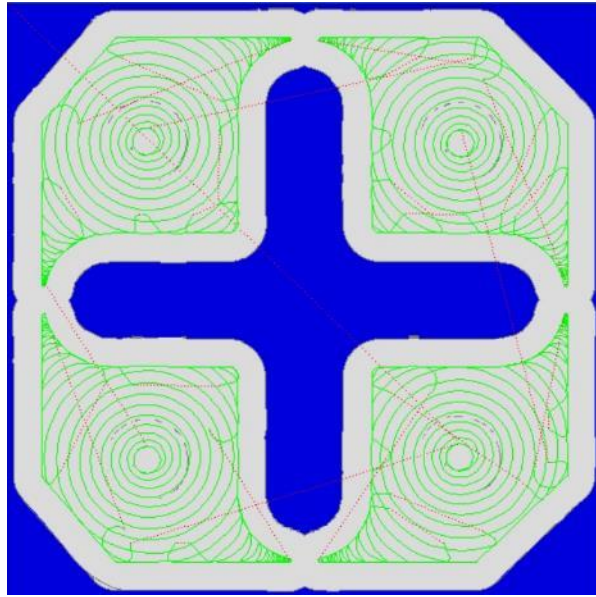

6.6 Options

The Options Info Key is active when you are in the Program Mode and you have choices for how you program a particular event. If it is not active, the space will be blank. Options give you additional choices for programming events and also allow you to override the default programming style. For example, if you have set the default Drilling to Variable Peck and you wish to change that to Fixed for this particular event, you can quickly do that in Options.

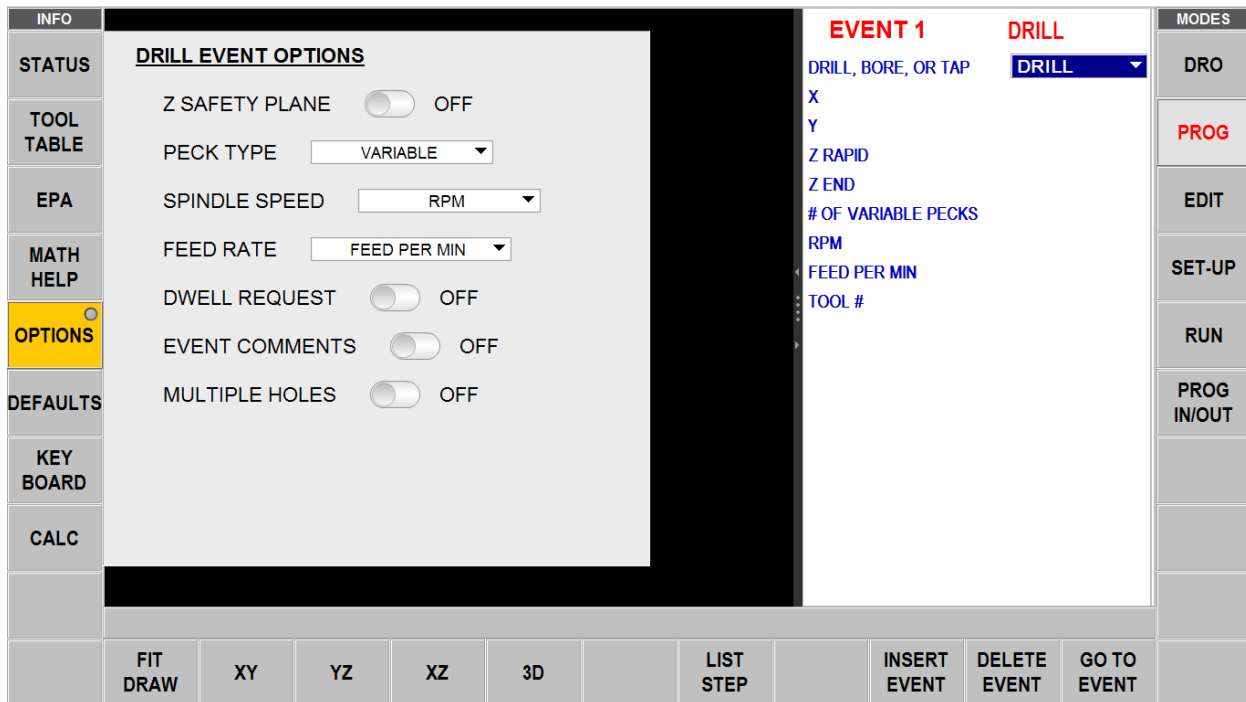

Figure 6.6 Options enables you to override the defaults on the fly

You set your overall programming style in the Defaults Info Key (Section 6.5 above), but change them on the fly in Options if you wish. If you find yourself frequently changing a default value, we highly recommend that you change the value in the Defaults Info Key.

Note: Changing a Default does not change a current program. For a changed Default value to appear in a program, the program must be opened or started after the change.

Programming variables found in Options

The options key is active when there are options for what is active in the window you are working in. In programming, the Options that appear when you tap the Options Info key depend on the event type.

Z Safety Plane

The Z Safety Plane is a setting to insure that every tool will not accidentally contact fixtures that stick up above the part. It is the distance from the part's Z Absolute Zero to the bottom of every tool in the spindle. When the Z Safety Plane is set to ON, a prompt will appear for entering the Z Safety plane value.

During program Run, the tool will move from Z Retract to Z Rapid for the first event. Between events, it will move to Z Safety Plane (instead of Z rapid) prior to an X, Y move.

Spindle Speed

RPM – spindle speed for the event in Revolutions per Minute

Surface Speed – Spindle Speed for the event in Surface Feet per Minute, which is the speed of the outside Diameter of the tool.

You may use Math Help Type 31 to convert an RPM value to SFM.

Event Comments

Turn this on in order to get the prompt to enter comments you wish to appear during program Run.

Peck Type

Override the default peck for the Drill event:

- Variable – progressively less each peck
- Fixed – same depth each peck
- Chip break – retracts 0.5mm between pecks

Chip break is the same as fixed but with a 0.5mm retract between pecks

Feed Rate

Overrides the default feed rate setting for the event:

Feed per minute in inches or mm per minute

Feed per tooth.

Dwell Request

Add a Dwell Time prompt to the Drill and Bore events measured in seconds. The dwell improves the finish on the floor of the hole.

Bottom Finish Cut

Turn this on to add a Z Finish Cut prompt in the Face Mill, Pocket or Island event. If a Z Finish Cut default was entered in the Defaults it will appear in the prompt.

Cutting method

Overrides the default cutting method for the event. The Cutting Method is explained in Section 6.5.

Step over percentage

Overrides the default step over percentage for the event. Step over percentage is explained in Section 6.5.

Machining angle in XY

Sets the angle the cutter will remove material from a pocket or island. 0° means it will rough along the X axis, 90° degrees means it will rough along the Y axis. You can select any angle between 0 and 90°.

Z Entry Method

Overrides the default Z entry method for the event. Z Entry Method is explained in Section 6.5.

Tool Path Pattern

Overrides the default tool path pattern for the event. Tool Path Pattern is explained in Section 6.5.

Order of Passes

Overrides the default order of passes for the event. Order of Passes is explained in Section 6.5.

Start Location

When using adaptive tool paths, you can turn on Start Location prompts that allow the user to program where the tool enters the workpiece. Turning this option on, adds an X START and Y START prompt within your event.

6.7 Keyboard

Tapping the Keyboard Info key will bring up the alphanumeric keyboard. Rather than being a Fly out window, the keyboard is a separate window that can be dragged around the screen for convenience. After the keyboard is opened, tap the field in which you want to type text or numbers. What you type must be set into memory using the Enter key (which is taken as an Abs Set entry). You may use the Abs Set and Inc Set keys on the keyboard as well as the hard keys.

Move the Keyboard by touching and holding the translucent bar at the top and dragging it to the desired position. Close the keyboard by tapping the X on the upper right corner.

6.8 Calculator

The CALC info key will open a new window with a calculator. Rather than being a Fly out window, the calculator is a separate window that can be moved around the screen. When a numeric input is required while programming, the Inc Set and Abs Set will set the calculated value into the field that is being programmed.

Move the Calculator by touching and holding the translucent bar at the top and dragging it to the desired position. Close the Calculator by tapping the X on the upper right corner.

7.0 DRO Mode

The ProtoTRAK RMX CNC operates in DRO Mode as a 3-axis digital readout. In addition to the large, easy-to-read dimensions, you have access to powerful capability that will make your manual work more productive than ever.

7.1 DRO Functions

Once you press the DRO Mode key, you will encounter the following screen:

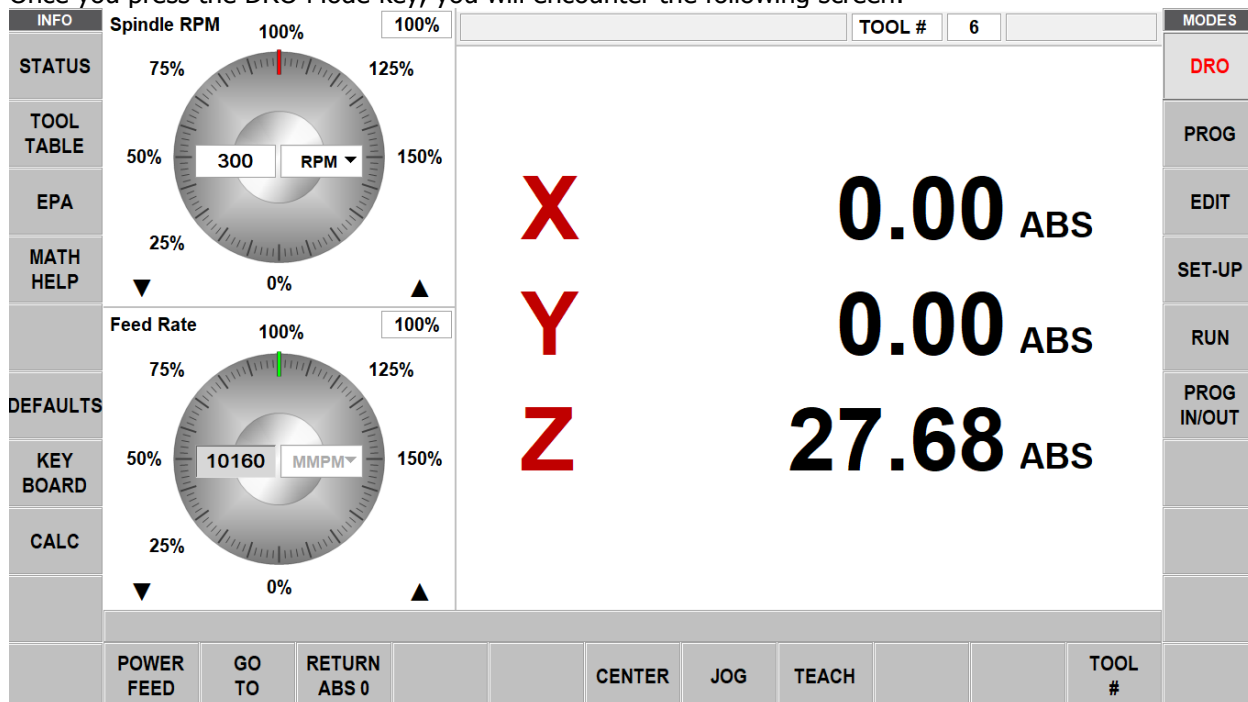

Inch to MM

To convert Inch to MM or MM to Inch tap the Status Info key and in Units at Start Up select Inch or MM. When you tap the Status key again the dimensions will be in the units you selected.

Selecting Dimension Reference

You may display your X, Y and Z dimensions in Incremental or Absolute for each axis. You may have a mixture of Absolute and incrementally dimensioned data.

To select between Absolute or Incremental Dimensions tap the ABS/INC label. The label and dimensions will toggle between Absolute and Incremental.

Resetting Dimensions

To reset, or zero out, Incremental Dimensions press the X, Y or Z hardkey and then the INC SET hardkey. The incremental dimension for that axis will be set to 0 (zero). Note, whenever you change your Absolute number, whether you reset or preset, you will reset (zero out) the Incremental Dimension.

To reset, or zero out, Absolute Dimensions press the X, Y or Z hardkey and then the ABS SET hardkey. The Absolute dimension for that axis will be set to 0 (zero). Please note that resetting the ABS Dimension will also reset the Incremental Dimension for that axis.

Presetting Dimensions

You can also enter preset dimensions in order to establish a reference from the current X, Y and Z position to some other point.

To preset an Incremental Dimension, press the X, Y or Z hardkey to select the axis. Enter the dimensional value and press INC SET. The incremental preset will have no effect on the Absolute dimension.

To preset an Absolute Dimension, press the X, Y or Z hardkey to select the axis. Enter the dimensional value and press ABS SET. Presetting an Absolute dimension will also reset (zero out) the Incremental dimension for that axis.

7.2 Apply Tool Library data to DRO operations (Advanced Features Option)

The ProtoTRAK RMX enables you to apply the tool offsets from your tool Library while you are working manually. This will save you from touching off tools that have already been set.

Note: you may access the Tool Library at any time by pressing the Tool Table info key.

1. Tap the TOOL # soft key.
2. Enter the desired Library number. The tool library number must be between 101 and 199.
3. The Z dimension will reflect the new Absolute dimension of the tool you entered. The Tool # at the top of the screen will display the tool number entered.
4. If you enter a tool # that doesn't exist in the Tool Library, no offset will be applied to the Z position.

7.3 Spindle RPM

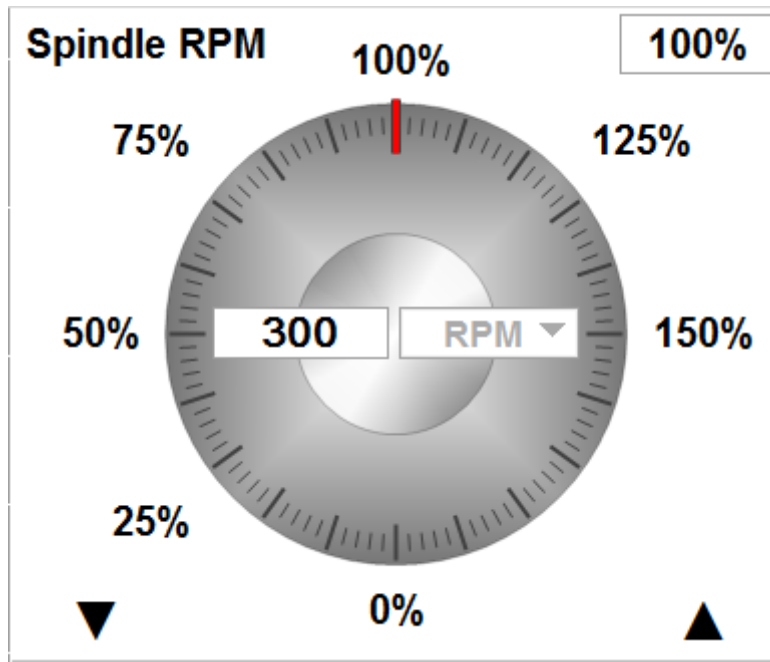

Figure 7.3 The Spindle Speed control in the DRO Mode.

7.3.1 Setting Spindle Speed and Values

To Set Spindle Speed tap the Spindle Speed box, enter the value up to the maximum and then press SET. The maximum RPM is set at the factory for the maximum rating of your machine model. To change the Values between RPM and SFM at Start up, tap Defaults and then Spindle Speed values.

7.3.2 Overriding Spindle Speed

You may override the set Spindle Speed from 0% of set up to 150%.

To override do one of the following:

- For fine adjustment, tap the up or down Fine Override arrow keys
- Tap one of the set % values around the graphical dial, for example, 75%.
- Drag your finger in a circular motion along the diameter of the graphical dial as if you were physically turning it. If you move your finger out to a larger radius, you will notice that this still allows adjustment of the feedrate. It gives the user a finer control of the feedrate

Note: As you "turn" the dial with your finger, the dial will "stick" to 100%. To resume turning, briefly lift your finger and put it back down. We put in this slight sticking at 100% so that you can move your attention away from the screen while ramping the override up or down.

As you apply overrides, the Spindle Speed and the Override % will update to the new values.

7.4 Feedrates in the DRO Mode

You can set and override in order to do Power Feed, Go To or one of the other powered operations in DRO Mode.

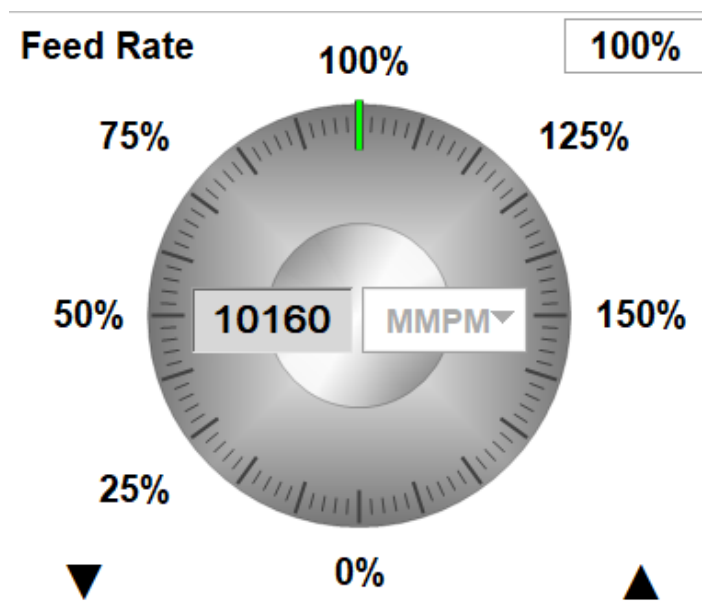

Figure 7.4 The Feedrate control in the DRO Mode

7.4.1 Setting Feedrate and Units

To Set Feedrate tap the Feedrate box, enter the value and the press SET.

To change the Values between IPM (Inch or mm per minute) and IPT (Inch or mm per tooth) at Start up, tap Defaults and then Feed Moves.

7.4.2 Overriding Feedrates

You may override the set Spindle Speed from 0% of set up to 150%.

To override do one of the following:

- For fine adjustment, tap the up or down Fine Override arrow keys
- Tap one of the set % values around the graphical dial, for example, 75%.
- Drag your finger in a circular motion along the diameter of the graphical dial as if you were physically turning it.

Note: *if you lift your finger while turning, the dial will "stick" to 100%. To resume turning, lift your finger again first then it will respond when being dragged. We put in this slight sticking so that you can move your attention away from the screen while ramping the override up or down.*

As you apply overrides, the Spindle Speed and the Override % will update to the new values.

7.5 Power Feed

The servomotors can be used as a power feed for the table, saddle or quill, or all three simultaneously.

- a. Press the POWER FEED soft key.
- b. A message box will appear that shows the power feed dimensions. All power feed moves are entered as incremental moves from the current position to the next position.
- c. Enter a position by pressing the axis key, the distance to go and the +/- key (if needed). Input the entry by pressing INC SET. For example, if you wanted to make a power feed move of 50mm of the table in the negative direction, you would enter: X, 50, +/-, INC SET.
- d. Do this for each axis you want to feed simultaneously. The message box will display what you've entered.
- e. Initiate the power feed move by pressing GO.
- f. The default Feed Rate is 254 mm / min. Enter a new number in the feedrate box. While the machine is moving use the Feed Override to adjust it.
- g. Press STOP to halt power feed. Press GO to resume.
- h. Press RETURN soft key to return to manual DRO operation.

7.6 Go To (TRAKing/Electronic Handwheels Option)

The Go To function in the DRO mode allows you to set an Absolute dimension in X or Y at which you want the machine to stop moving when you are turning manually. For example, if you wanted to machine manually to 50mm Absolute, you would input: Go To, X, 50, ABS SET. While the Go To window is displayed, the ProtoTRAK RMX will not let you pass that 50mm dimension you set.

- a. Press the GO TO soft key.
- b. Enter the axis, X or Y or both in turn.
- c. Input the dimension(s).
- d. Press Abs Set.
- e. Turn the handwheel. Motion will stop at the entered dimension even if you continue to turn the handwheel.

7.7 Return to Absolute Zero

At any time during manual DRO operation you may automatically move the table to your Absolute zero location in X and Y by pressing the RETURN ABS 0 soft key. When you do, the message window will read "Ready to Begin: Press Go when Ready".

Make sure your tool is clear and press the GO key. The servos will turn on, move the head to Z retract then move the table at rapid speed to your X and Y absolute zero position, and then turn off. You will be at zero and in manual DRO operation. When you are in 2-axis CNC operation, only the X and Y will move, the head will not.

7.8 Center

The ProtoTRAK RMX will calculate the centres of lines and circles for you.

1. Press CENTER.
2. Select Line Centre or Circle Centre.
3. Follow the prompts in the message box on the screen.

The ProtoTRAK RMX will calculate the centre from the information you've given it and display this calculation in the message box. If you desire, the control will feed at 2540mm to the centre location it calculated.

7.9 Jog

The servomotors can be used to jog the table, saddle and head.

1. Press the **JOG** soft key. A flashing message will appear saying "CAUTION: JOG KEYS ARE ACTIVE".
2. To jog, press the X, Y or Z hard keys.
Warning: Motion will occur!
3. To stop jogging, release the key.
4. The default feed is the maximum of 10160mm/min for the X and Y axis and 6350mm / min for the Z axis or the number you entered in Defaults.
5. Press the **+/-** hard key to reverse direction. When the number in the Feed rate box is negative, this indicates the minus direction.
6. Use the Feed Override functions to jog at a different speed.

7.10 Teach

Teach gives you the ability to create a program by manually mimicking the moves you wish for the CNC to make. It can be a useful way of entering a few manual moves for operations like clearing out excess material or remembering a few hole locations.

The process of using Teach is in two parts. The first part takes place in the DRO Mode. This is where you start the Teach program, establish the program events and enter the X and Y dimensions. The second part is in the Program Mode. This is where you complete the Teach events that you began in the DRO Mode by entering the rest of the data. Once the data is entered, the Teach events become just like the other events that make up a program.

Entering Teach Data

From the DRO Mode, press Teach. On the top of the screen, you will see an event counter.

The event counter shows the event for which data is being entered. You may teach in position, drill and mill events only.

On the first Teach screen, the soft keys are:

Posn: a position move. For two-axis programming, the POSN and DRILL events are combined.

Drill: a drill or bore.

Mill begin: the beginning of a straight line or MILL event.

End teach: ends the teaching process and returns you to the main DRO screen.

If you press the POSN or DRILL key, the event counter will go up by one and the screen remains the same. If you press the MILL BEGIN key, the event counter stays on the same number. That is because you have given the beginning point of the line but not yet the end. The soft key selections will change to:

MILL end: the last point of the Mill event. Press this to end the Mill event and select a POSN, DRILL or new MILL event.

Mill cont: the last point of the current Mill event, but the beginning of the next Mill event. You may enter successive Mill events by pressing the MILL CONT key.

Pressing either of the above soft keys will cause the event counter to increase by one.

At any time you may exit the Teach and return to the DRO screen.

Converting Teach Data to a Program

When you enter Teach, you are actually programming events. If there is already a program in current memory, Teaching will add events to the end of the program. If there is not already a program in current memory, Teaching will start a new program. For example, if you already had a program in current memory that had 10 events, when you press Teach, the event counter will say EVENT 11. If there was no program, the event counter will say EVENT 1.

So far, you have entered dimensions, but the ProtoTRAK RMX will need a little more information before you can make parts. The events you have defined with their X and Y dimensions are finished in the Program Mode.

8.0 Program Mode Part 1: Getting Started and Some General Info

8.1 Programming Overview

The ProtoTRAK RMX CNC makes programming easy by allowing you to program the actual part geometry as defined by the print.

The basic strategy is to first fill in the initial program information in the Program Header screen and then program the features of the part by selecting the soft key event types (geometry) and then fill in the prompts one-by-one.

Enter the Program Mode by tapping the PROG Mode key. If you exit the Program Mode, the same screen displayed when you exit will be there when you return.

The ProtoTRAK RMX CNC will allow only one program in current memory. To write a new program, you must first erase the one in current memory (you may want to first store the program for use in the future). If there is already a program in current memory, entering the Program mode will allow you to edit or add to that program.

To open a previously stored program, see Program In/out mode.

8.2 Info Keys

The ProtoTRAK RMX gives you extraordinary power and control over how your part is machined. As you are programming, you may use the Info Keys at any time:

Status – quick check of Program Name and other information.

Tool Table – check tool reference information or set up your tools *as you program*.

EPA – quick reference information on relevant topics to get you past some uncertainty about how to do something.

Math Help – convenient routines to help you calculate missing print data. Answers may be loaded directly into the program event.

Defaults – change the programming style that you have defined on the fly to fit the current work. Any changes to Defaults will take place for the next event you select.

Options – Override Defaults or initiate additional capability that you may need on a particular event. If you find yourself frequently overriding a Default, you may want to consider changing the Default itself.

Keyboard – Alphanumeric text and symbols for you to use to name the program or to enter in Engrave events (Advanced Features Option).

Calculator – basic calculator for quick math. Answers may be directly loaded into the event.

When you are finished with the Info Key, simply tap the key again to put the window away. Close the Keyboard and Calculator by tapping the X on the upper right corner of their window.

8.3 Program Header (Event 0) Screen

The first screen you see when you enter the Program Mode is the Program Header Screen.

The program name and general programming options you choose in the Program Header Screen will be summarized in the program as "Event 0".

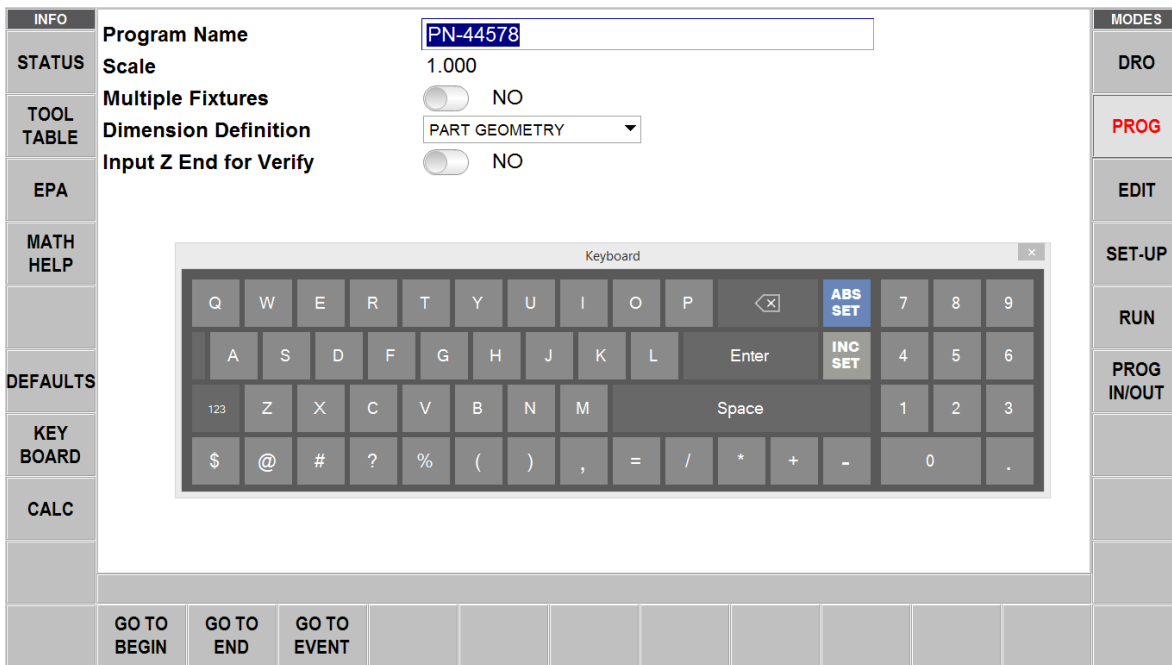

Figure 8.3 The Program Header screen (event 0) with the Keyboard open for entering the part number.

Program Name: data is entered using the keyboard or the Data Input hard keys. Press either SET after entering. Program names may be any length, but only 40 characters will be displayed in the field of the program name and up to 35 characters will be displayed in the Program Name field in the Status screen.

Scale: Allows a scale factor between .1 and 10. An input of 5 means the part will be 5 times as big as the programmed dimensions. A value of 1.0000 is assumed if nothing is input.

Multiple Fixtures: Asks you if you wish to turn on the multiple fixtures offset. Answering Yes will cause a prompt to appear at each event asking which fixture the event was referenced from. See below for more explanation of how to use Multiple Fixtures. Multiple Fixtures is an Advanced Feature.

Dimension Definition: The ProtoTRAK RMX CNC gives you a choice in programming either tool path or geometry. Part Geometry programming allows you to define the geometry for your part and then the CNC does the difficult job of calculating tool path for you automatically. This is a great benefit for most parts most of the time because it means that the CNC is doing the hard work of determining tool position.

One restriction to part geometry programming is that for events to be connective, they must lay on the same plane (see Section 5.3 for a definition of planes). For this reason, the ProtoTRAK RMX CNC gives you the option of entering your own tool path. If you wish to program the part by defining tool path yourself, you may choose the TOOL PATH. Otherwise, Part Geometry programming is assumed. Tool Path operates under the same rules as standard RS274.

A program must be entirely written in Part Geometry or Tool Path programming, you cannot combine the two methods in one program.

Input Z End for Verify (Verify Option): This prompt will appear only if you have the Verify option and you are writing a 2-axis part program. If you select Yes you will be prompted for Z End information in each event. This is needed to show the depth for each event on the solid model of the part you program.

Go to Begin: Takes you from the Header Screen to the first event of the program. You may also simply swipe to the left.

Go to End: Takes you from the Header Screen to the last event of the program.

Go to Event: will prompt you to enter an event number, then takes you to that event when you press SET.

8.4 Starting to Program

To start programming, select Go To Begin or simply swipe the screen to the right to launch Event 1. At any time you may move between the header and between events by swiping.

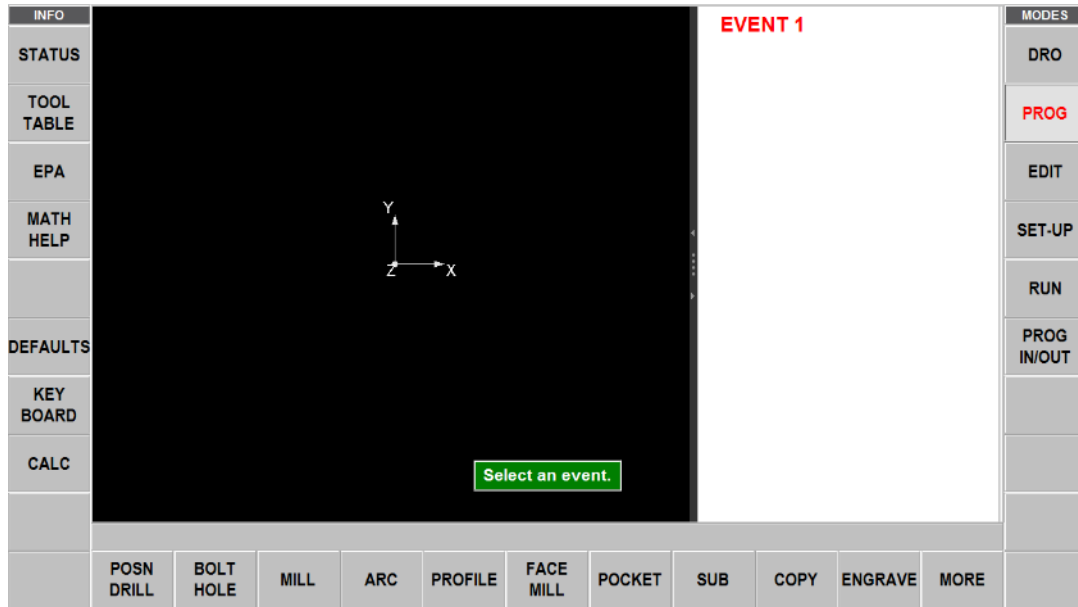

When an event is selected, all the prompts that need to be input will be shown on the right side of the screen. The first prompt will be highlighted. Input the dimension or data requested and press INC SET or ABS SET. For X, Y or Z dimension data it is very important to properly select INC SET or ABS SET. For all other data either SET will do.

When all data for an event has been entered, the entire event will be shifted to the left side of the screen if shown and the message box will ask you to select the next event.

8.5 Part Drawing while Programming

As you program, your inputs will be used to make a drawing of the part to show you what you've programmed so far. You may display one or two events by swiping the right edge of the border of the drawing and the drawing will automatically resize to the amount of screen left to it.

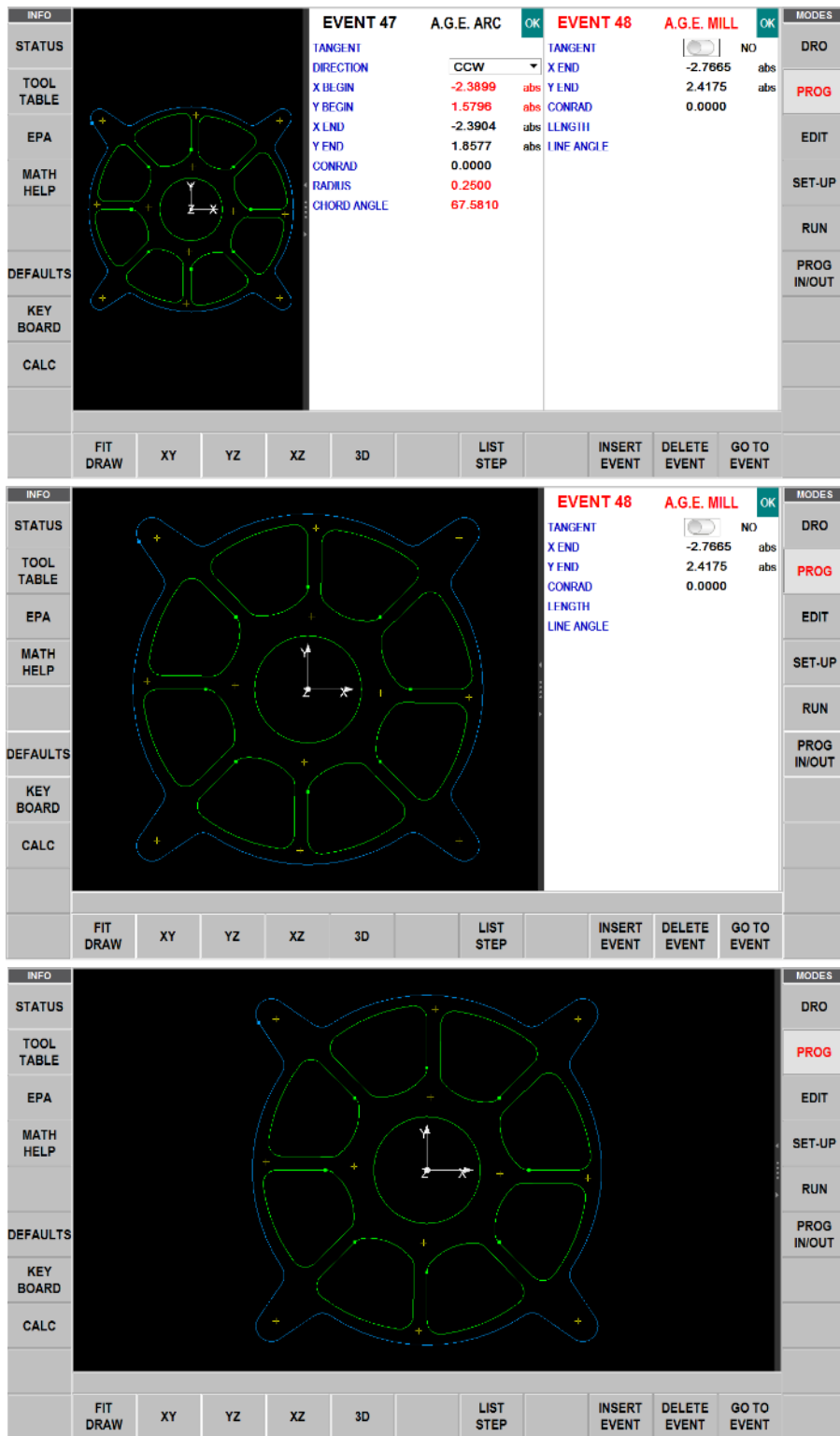

Figure 8.5 Swipe the screen to select between views of the events and drawing

8.6 Soft Keys within the Event

Program Events will be described in the next section.

Once an event geometry is selected, the following Soft Keys will appear.

FIT DRAW	XY	YZ	XZ	3D		LIST STEP		INSERT EVENT	DELETE EVENT	GO TO EVENT
-------------	----	----	----	----	--	--------------	--	-----------------	-----------------	----------------

Figure 8.6 Soft Keys within an event.

Fit Draw: resize the drawing to fit the screen after you have zoomed or pinched it.

XY: XY Plane view of part

YZ: YZ plane view of part

XZ: XZ plane view of part

3D: 3D view of part

LIST STEP: launches a process to show the part geometry as related to the Event type and number.

INSERT EVENT: use this to insert a new event into the program. This new event will take the place of the one that was on the right side of the screen when you pressed the **INSERT EVENT** key. That previous event, and all the events that follow, increase their event number by one. For example, if you started with a program of four events, if you were to press the INSERT EVENT key while Event 3 was on the right side of the screen, the previous Event 3 would become Event 4 and the previous Event 4 would become Event 5. If you insert a Subroutine event, the event numbers will increase by one as when you insert another kind of event. If you insert a copy event, the event numbers will increase by the number of events that are copied.

DELETE EVENT: deletes the event on the right side of the screen.

GO TO EVENT: Jumps you to the event you input.

When the LIST STEP key is selected, a list of the Event numbers and types appear on the right side of the screen and additional Soft Keys appear at the bottom:

STEP FWD: Each key press moves you up in event number. As this occurs, the drawing will highlight the geometry in the event by turning to purple and the event number will appear in the upper left of the drawing screen.

STEP BACK: Moves backward through the drawing.

START AT EVENT: Jumps you to the Event number in the drawing that you input.

RETURN: Takes you back to the previous soft key selections and screen view.

8.7 Z Rapid and Safety Plane

Many events will give you the option of turning on and programming a Z Safety Plane. The Z Safety Plane is a dimension in Z Absolute that you define. It is there to allow you to program a Z move needed to clear an obstruction.

For example, say you had Mill event as Event 1 and a Pocket event as Event 2, and on the part there is a clamp between the end of Event 1 and the beginning of Event 2. The normal toolpath at the end of Event 1 would be:

Z moves to the higher of Z rapid for Event 1 and Event 2

XY moves at rapid to the beginning of Event 2.

Z moves to Z rapid of Event 2, then to XYZ beginning of Event 2

This direct path between events would cause the tool to hit the clamp. In order to avoid this, you could enter a Z Safety plane within event 1. The toolpath would then be:

Z moves to the Z Safety Plane set in event 1 before going to Event 2
XY moves at rapid to the beginning of Event 2.
Z moves to Z rapid of Event 2, then to XYZ beginning of Event 2

8.8 Editing Data while Programming

In addition to the List Step view, The ProtoTRAK RMX CNC allows you to move easily through your program by swiping the events back and forth. Previously programmed prompts and events may be easily edited. With your event on the right side of the screen, tap the data that you wish to change or replace. Simply enter the desired data and press INC SET or ABS SET. The ProtoTRAK RMX will adjust the program and update the drawing.

8.9 Finish Cuts

When applicable for the event geometry, a Finish Cut prompt will appear. If a value is entered, the prompts for Finish Feedrate, Finish RPM and Finish Tool # will remain. If a 0 is entered, indicating no finish cut, those prompts will disappear.

When a finish cut is programmed, the ProtoTRAK RMX will first rough out the material, leaving the amount of material specified in the Finish Cut prompt. This material will be machined at the programmed Finish Feedrate and RPM and with the programmed Finish tool.

A default value for finish cuts for Pockets, Profiles and Islands may be set in the Defaults Info Key.

8.10 Programming in 2 vs 3 axis

The ProtoTRAK RMX may be programmed in either 2 or 3 axis. Each program must be entirely in either 2 or 3-axis. When programming in 2 axis, the prompts for Z will not appear.

You can change your Mode between 2 and 3 axis with the Status Info key. When you change, the screen will revert to the Start Up screen.

8.11 Using multiple fixtures (Advanced Features Option)

When you want to use multiple fixtures, set the Multiple Fixtures setting in the Program Header screen to Yes.

You may run your program using up to six fixtures with the first fixture being the base fixture. A fixture is a location on your machine with a defined offset from your absolute 0. When you program an event to have a fixture, it will treat the offset as if it were absolute zero shift. The programmed X, Y and Z absolute dimensions are relative to the absolute reference for the specified fixture.

For example, say you had two vices on the table. On the first vice, you established the lower left jaw as the absolute 0. At the same time, you measured the distance between the absolute zero you just established and the lower left jaw of the other vice. You entered that measurement as an offset from your base vice (the first one) and the other vice, which is Fixture #2. Any events that you programmed using Fixture #2 would treat the lower left corner of that second vice like the absolute 0 for the X, Y and Z dimensions in the events.

Fixture offsets are handy for combining different programs together to run at the same time or to make multiple parts by repeating the events with different fixtures.

The fixture offsets are entered in the Set-up mode. There is a base fixture, called fixture number one. We recommend that Event #1 in your program uses fixture number one. It doesn't have to; we just believe it is clearer that way.

8.11.1 Fixtures and Running the Program

To run the program, first go to the DRO mode and set absolute 0 at the base fixture, Fixture #1.

In the Run mode, the SHOW ABS displays the absolute position relative to the fixture in the event being run, that is, the absolute dimension that was programmed.

8.11.2 Editing Fixtures

With the Multiple Fixtures feature turned to YES, you may edit the fixture number in the Program Mode event by event. You may also use the Search Edit feature in the Edit Mode to change fixture numbers. See Section 12.3 for setting up fixture offsets.

9.0 Program Mode Part 2: Program Events

Events are fully defined pieces of geometry. By programming events, you tell the ProtoTRAK RMX CNC what geometry you want to end up with; it figures the tool path for you from your answers to the prompts and the tool information you give it in the Set-Up Mode.

In the ProtoTRAK RMX, defining your event is made even easier by the interaction of the Defaults you may set to define your programming style and the Options that enable you to change defaults or have additional functions.

Please see section 6.5 for information about Defaults and 6.6 for information about Options.

9.1 Prompts Found in Events

The following is a description of the Prompts you'll encounter after selecting an Event. Only the prompts appropriate to the event you select will appear.

Holes: the number of holes in the bolt hole pattern

Passes: The number of cycles to machine to the final depth spaced equally from Z Rapid to Z End (hint: keep Z Rapid small).

PECKS: the default is displayed either Variable, Fixed or Chip Break. You may override the default by choosing the Options Info key.

Repeats: the number of times the programmed events are repeated in the Subroutine events.

Rest Passes: The number of cycles to machine to the final depth in the rest (residual) material with the finish tool.

% Feed: the percentage of the feeds in the programmed events to apply to the Subroutine events.

% RPM: the percentage of RPM in the programmed events to apply to the Subroutine events.

Angle: The angle from the positive X axes (that is, 3 o'clock); positive angle is measured counterclockwise from 0.000 to 359.999 degrees, negative angles measured clockwise.

Conrad: The dimension of a tangential radius to the next event (that must lie in the same plane for part geometry programming). May also be the corner radii of a rectangular pocket.

Direction: The clockwise or counterclockwise direction of the arc as viewed looking down for an arc in the XY plane, looking from the front for a vertical plane, or looking from the right for a vertical YZ plane

FEED PER MIN: the Feedrate in Inch per minute or mm per minute

FEED PER TOOTH: the Feedrate in inch or mm per tooth. The number of flutes must be defined for the tool in the Tool Table

FIN CUT: The width of the finish cut. If 0 is input there will be no finish cut. You will not receive this or the other Finish prompts if the TOOL OFFSET is Tool Centre.

FIN FEED PER MIN: The finish cut milling feedrate in in/min from .1 to 400 (250 for Z), or mm/min from 5 to 10160 (6350 for Z)

FIN FEED PER TOOTH: the Finish cut feedrate in inch or mm per tooth. The number of flutes must be defined for the tool in the Tool Table

FIN RPM: The spindle RPM for the finish cut.

FIN SURFACE SPEED: Finish Surface Speed in Surface Feet per Minute, which is the speed of the outside Diameter of the tool

FIN TOOL #: Tool number you assign for the Finish Cut.

First Event #: the event number of the first programmed event for the subroutine.

Last Event #: the event number of the last programmed event of the subroutine.

Mirror Axis: the selection of the axis or axes to be mirrored (input X or Y or XY, SET) in the Subroutine Mirror Events.

Pitch: the distance from one thread to the next in inches or mm. It is equal to one divided by the number of threads per inch. For example, the pitch for a 1/4-20 screw is $1 / 20 = .05$ inches or 1.27mm.

Radius: The finish radius of the arc circle or the bolt hole pattern

RPM / SFM: the default is displayed either RPM or SFM. You may override the default by choosing the Options Info key.

Spindle Speed is programmed as either **RPM** or **Surface Feed**.

Tool #: The tool number you assign. SET without a number will use the tool number of the previous event.

Tool Offset: The selection of the tool offset to right, offset to left or tool centre (no offset) relative to the programmed edge and direction of tool cutter movement and as projected in the XY plane

X Begin: The X dimension to the beginning of the mill or arc cut

X Centre: The X dimension to the centre of the arc or bolt hole pattern; incremental is from X End

X End: The X dimension to the end of the cut; incremental is from X Begin

X: The X dimension to the hole

X1: the X dimension to the first diagonal point of a rectangle.

X3: the X dimension to the opposite diagonal point of a rectangle.

XYZ FEED PER MIN: the milling feedrate in inches or mm per minute

XYZ FEED PER TOOTH: the XYZ milling feed rate per tooth in inches or mm. This is the chip thickness.

Y Begin: The Y dimension to the beginning of the cut

Y Centre: The Y dimension to the centre of the arc or bolt hole pattern; incremental is from Y End

Y END: The Y dimension to the end of the cut; incremental is from Y Begin

Y: The Y dimension to the hole

Y1: the Y dimension to the first diagonal point of a rectangle.

Y3: the Y dimension to the opposite diagonal point of a rectangle.

Z Begin: The Z dimension to the beginning of the cut

Z Centre: The Z dimension to the centre of the arc; incremental is from Z End.

Z End: The Z dimension to the end of the cut; incremental is Z Begin

Z FEED PER MIN: the drilling or vertical milling feed rate in inch or mm per minute

Z FEED PER TOOTH: the Z direction milling feed rate per tooth in inches or mm. This is the chip thickness.

Z Rapid The Z dimension at which the Z stops rapid and begins to feed at the programmed Z feed rate.

9.2 Event Types

9.2.1 POSN: Position Events

This event type positions the table and quill at a specified position. The positioning is always at rapid speed (modified by feedrate override) and in the most direct path possible from the previous location.

9.2.2 DRILL TAP Event

This will drill, bore or tap a hole in the XY location that you enter.

Press the DRILL TAP soft key.

Drill, Bore, Tap: selects whether the hole is to be drilled, bored or tapped.

Drill

This positions the table to the specified X and Y position, moves the HEAD at rapid to the Z RAPID location, feeds to the Z END location, and rapids back to Z RAPID.

Bore

This positions the table to the specified X and Y position, moves the HEAD at rapid to the Z RAPID location, feeds to the Z END location, and feeds back to Z RAPID.

Tap

This positions the table to the specified X and Y position, moves the HEAD at rapid to the Z RAPID location, coordinates the spindle and feeds from Z rapid to the Z END location, and feeds back to Z RAPID.

Tapping Notes and Recommendations

- Harder materials will require slower speeds and tap size may also be limited. For example, the TRAK Bed Mill may not be capable of tapping a M18 thread in inconel.
- Make sure your tap is not dull. Dull taps will require more torque to cut and may not cut threads to specification.
- Cutting oil will play a large role in determining the size of tap you can use in a given material.
- A common problem with tapping is having adequate float in the tension and compression stroke. The holder should float up and down with minimal force applied to the holder. Also make sure your holder does not stick in tension (holder pulls down) or compression (holder pulls up). This will stop the tap from getting to the correct position programmed and may also break your tap.
- Always set your Z rapid higher than the tension stroke of your holder. This will save your tap if the holder does get stuck in the tension stroke between holes.
- Make sure your tap is running true in the holder.
- Most tapping problems are due to a dull tap or a holder that is not floating and is stuck in a certain position.

9.2.3 Bolt Hole

This will drill, bore or tap a series of holes evenly spaced around a centre you define.

Bolt Hole Drill

This positions the table to the specified X and Y position, moves the HEAD at rapid to the Z RAPID location, feeds to the Z END location, and rapids back to Z RAPID.

Bolt Hole Bore

This positions the table to the specified X and Y position, moves the HEAD at rapid to the Z RAPID location, feeds to the Z END location, and feeds back to Z RAPID.

Bolt Hole Tap

This positions the table to the specified X and Y position, moves the HEAD at rapid to the Z RAPID location, coordinates the spindle and feed at Z Begin, feeds to the Z END location, and feeds back to Z RAPID.

9.2.4 Mill

This event allows you to mill in a straight line from any one XYZ point to another, including at a diagonal in space. It may be programmed with a CONRAD if it is connective with the next event (this next event must lie in the same plane as the Mill event).

9.2.5 Arc

This event allows you to mill with circular contouring any arc (fraction of a circle) that lies in the XY plane or a vertical plane. Vertical plane arcs are also limited to those that are entirely concave or convex (in other words, if you think of the arc lying on the surface of the earth, then it can't cross the equator).

In ARC events when X Centre, Y Centre, and Z Centre are programmed incrementally, they are referenced from X End, Y End, and Z End respectively. An ARC event may be programmed with a CONRAD if it is connective with the next event (this next event must lie in the same plane as the Arc event).

Note: *When an arc is 180°, there are several paths that all have the same beginning, ending, and centre locations. To illustrate, Imagine that if you were on the earth's equator and you wanted to get to the other side of the earth you could go clockwise or counterclockwise around the equator, or you could go up over the north pole, or down under the south pole. The ProtoTRAK RMX CNC will automatically assume that all 180° arcs that have the same beginning, ending and centre dimensions for Z, lie in the XY plane. If you want a 180° arc in a vertical plane, you must program two 90° arcs or some equivalent.*

9.2.6 PROFILE Events

These events allow you to mill around the outside or inside of a circular or rectangular frame or an irregular profile. The irregular profile may be closed or open. All profiles are limited to the XY plane. When the irregular profile event is started the ProtoTRAK RMX CNC will automatically initiate the powerful Auto Geometry Engine. See Section 10.0 for more information about programming with A.G.E.

Finish cuts and the number of passes are automatically programmed for Profile events if these values are set in the Default Info key. Finish Cuts are only programmed when the Tool Right or Tool Left positions are selected.

Circle profile

Press the CIRCLE soft key if you wish to mill a circular frame.

Rectangular Profile

Press the RECTANGLE soft key if you wish to mill a rectangular frame with or without corner radii (all corners are 90° right angles).

Irregular Profile

Press the IRREG PROFILE soft key if you wish to mill a profile other than a rectangle or circle. The Irregular Profile event initiates the powerful Auto Geometry Engine to define a shape made up of straight lines (Mills) and arcs. See section 10 for more information about programming with the powerful AGE feature.

The Irregular Profile is a series of events that are programmed to machine continuously. The first event of the series will be called an IRR PROFILE and it will define the beginning point of the profile and other machining information that applies to the entire profile.

When the initial Irregular Profile screen is complete, the rest of the profile is programmed using A.G.E. Mill and A.G.E. Arc events. Programming with the Auto Geometry Engine is explained in Section 10.0.

9.2.7 Face Mill

The Face Mill event will cut a rectangular area you define by opposite corners. The toolpath for the Face Mill Event always starts off the area you define and machines the top of the part using the Step Over Percentage and the Cutting Method you define in the Defaults.

9.2.8 Pocket Events

This event selection gives you a choice between, circle pocket, rectangular pocket and irregular pocket within the XY plane.

Pockets include machining the circumference, as well as all the material inside the circumference of the programmed shape. If a finished cut is programmed, it will be made at the completion of the final pass. The cutter will arc in and arc out of the finish cut and position itself the finish cut dimension away from the part before moving the tool out of the part.

See Section 6.5.4 for the Defaults that you can set for Pocket Events.

Circle Pocket

The Circle Pocket will machine the circumference defined and the material on the inside. You may place Islands inside a circle pocket.

Rectangular Pocket

The rectangular Pocket will mill a rectangular shape with all corners 90 degree right angles and the sides parallel to the X and Y axes and the material on the inside. You may place Islands inside a rectangular pocket.

Irregular Pocket

The Irregular Pocket event gives you the powerful Auto Geometry Engine to define a shape made up of straight lines (Mills) and arcs.

The first screen in an irregular pocket event will define the beginning point and some of its general parameters. The last event of the irregular pocket must end at the same point as defined in the first event. A Conrad may be added to the last event of an Irregular Pocket and it will be inserted between the end of the last event and the beginning of the first event.

9.2.9 Islands Events

Island Events are programmed by first selecting Pocket and then Island.

An island is a shape that is left standing when the surrounding material is removed. The ProtoTRAK gives you the ability to machine almost any shape as an island within a pocket. You may place Islands inside an irregular pocket event.

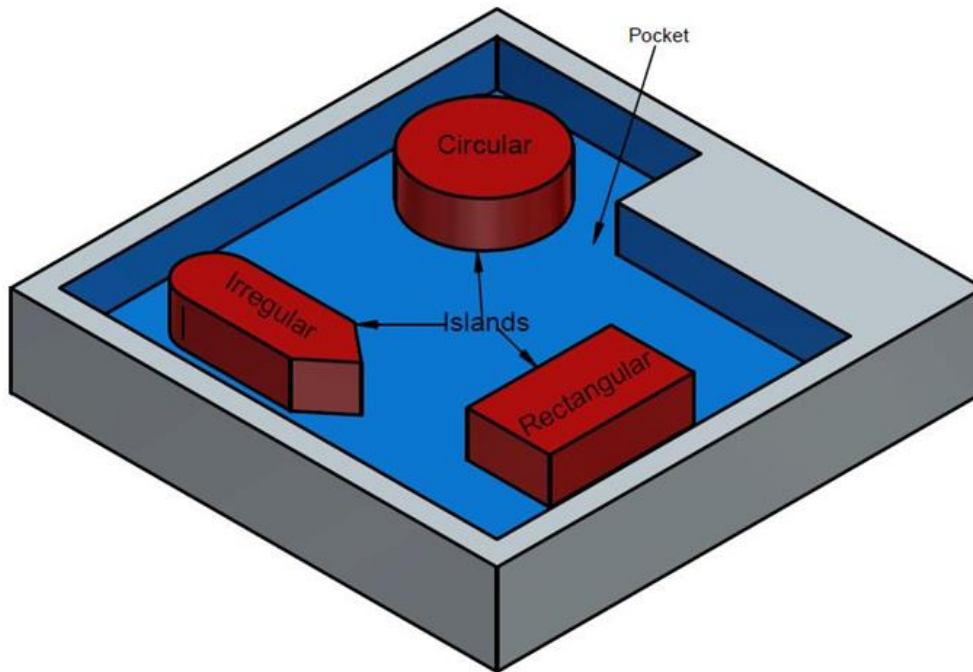

Figure 9.2.9 Islands of any shape may be programmed within a pocket.

This powerful feature gives you an easy way to do complicated shapes. In order to organize it properly, the ProtoTRAK RMX guides you through a sequence that helps keep things clear as you go.

First, from the Select an Event screen, you select POCKET.

Next, select ISLAND.

Next, you will program the Pocket in which the island will sit.

Once the Pocket is defined, you will have a choice of Island shapes:

CIRCLE ISLAND – the centre and radius are defined.

RECTANGULAR ISLAND - a rectangular shape with all corners 90 degree right angles and the sides parallel to the X and Y axes.

IRREGULAR ISLAND – initiates the powerful Auto Geometry Engine for you to define a shape made up of straight line and arcs.

END ISLAND – tells the ProtoTRAK that you have no more islands to place inside the pocket.

9.2.10 Subroutine Events

The Subroutine Events are used for manipulating previously programmed geometry within the XY plane.

The Subroutine Event is divided into three options: Repeat, Mirror, and Rotate.

Repeat and Rotate may be connective. As long as the rules of connectivity are satisfied you may add subsequent events.

REPEAT allows you to repeat an event or a group of events up to 99 times with an offset in X and/or Y and/or Z. This can be useful for drilling a series of evenly spaced holes, duplicating some machined shapes, or even repeating an entire program with an offset for a second fixture.

Repeat events may be "nested." That is, you can repeat a repeat event, of a repeat event, of some programmed event(s). One new tool number may be assigned for each Repeat Event.

MIRROR (Advanced Features Option) is used for parts that have symmetrical patterns or mirror image patterns. In addition to specifying the events to be repeated, you must also indicate the axis or axes (X or Y or XY are allowed) that the reflection is mirrored across. In addition, you must specify the offset from absolute zero to the line of reflection. You may not mirror another mirror event, or mirror a rotate event. Consider the figure below:

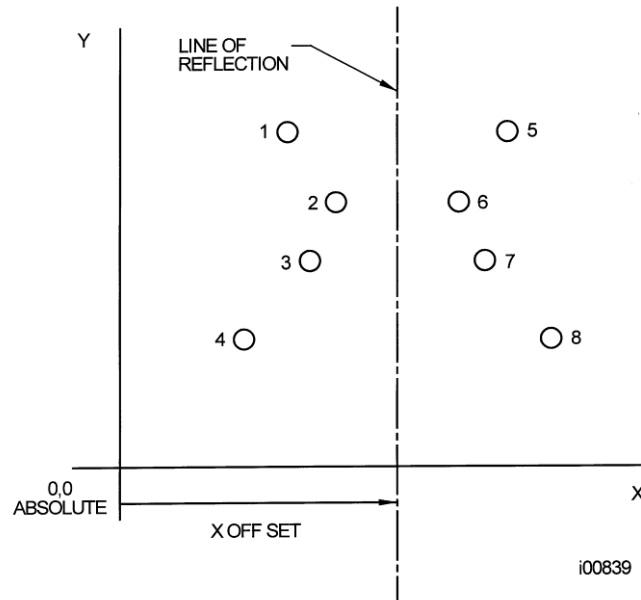
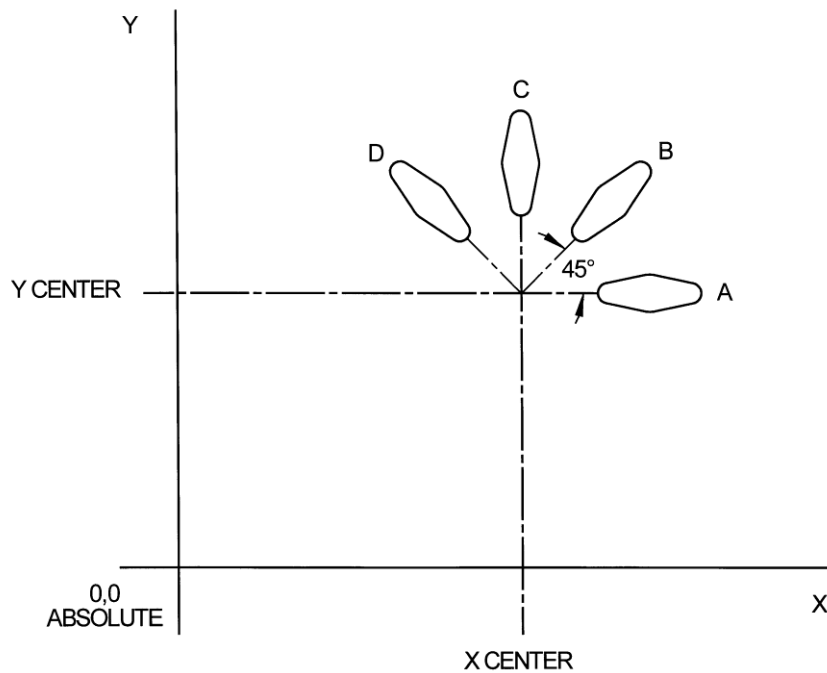

FIGURE 9.2.10a Holes 1-4 are mirrored across the Y axis to 5-8, respectively, about a line X OFFSET from X=absolute 0

CUTTING ORDER: Forward – the toolpath is from the first event to the last event. Backward – the toolpath is from the last event to the first event.

ROTATE is used for polar rotation of parts that have a rotational symmetry around some point in the XY plane. In addition to specifying the events to be repeated, you must also indicate the absolute X and Y position of the centre of rotation, the angle of rotation (measured counterclockwise as positive; and clockwise as negative), and the number of times the specified events are to be rotated and repeated. You may not rotate another rotate event, however you can rotate a mirror event. Consider the figure below:



i00840

FIGURE 9.2.10b Shape A programmed with 4 MILL events and Conrads. Using ROTATE, these 4 events are rotated through a 45 degree angle about a point offset from absolute zero by X Centre and Y Centre dimensions. A is rotated 3 times to produce shape B, C, and D.

9.2.11 Copy Events

Copy Events are programmed exactly like Subroutine Events. The only difference is that in Copy the events are rewritten into subsequent events. If, for example, in event 11 you Copy Repeated events 6, 7, 8, 9, 10 with 2 repeats, events 6-10 would be copied with the input offsets into events 11-15, and recopied into 16-20. Copy Events may be Repeat, Mirror, Rotate or Drill to Tap.

Copy is very useful. With Copy you can:

Edit the events that are being repeated, mirrored or rotated without changing the original events.

Connect so that the quill will not move up to the Z Rapid position, and back down unnecessarily. However, to be connective, you must be certain that the X, Y, Z begin of the first event, once offset or rotated, coincides with the X, Y, Z end of the last event.

Program an event parallel to X or Y (where the geometry is the easiest to describe), rotate it to the desired position, then delete the original.

Convert a series of drill events to a tap events.

Use the Clipboard (option) to paste previously stored events from another program into the current program. After you press the Clipboard key, you will enter the offset from the previous program's absolute zero to the current program's absolute zero (see figure below). For information about putting events into the clipboard, see Section 11.5.

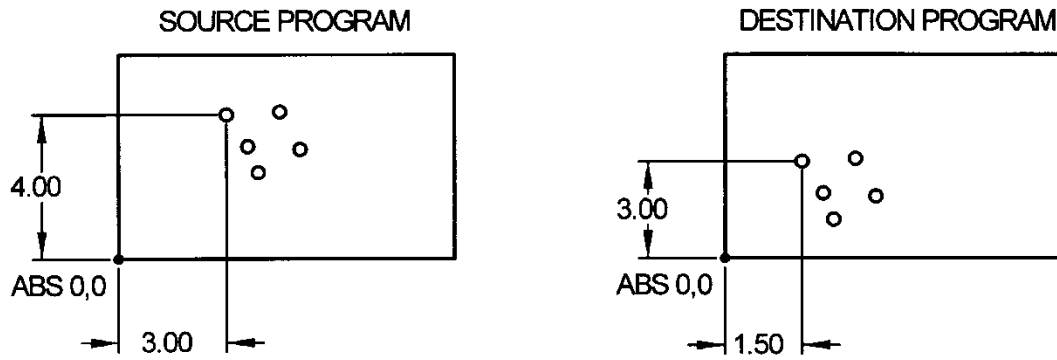

i00965

Figure 9.2.11 In the above example, the offset that puts the group of holes in the desired location is $X=-1.50$ and $Y=-1.00$.

9.2.12 Helix event

The Helix event will allow you to precisely define a helical tool path.

Notes:

There is a separate Thread Mill Event for thread milling.

You may quickly and easily program your cutter to enter Pockets and clear off events in a helical move. Simply set the Default Z Entry Method to Helical.

9.2.13 Engrave

The Engrave Event allows you to machine numbers, letters and special characters as part of a part program.

When programming with the Engrave Event, the ProtoTRAK will construct a box to contain the text you define. This box is oriented along the X axis like the text in this sentence. To machine text in a direction other than the X axis, simply use multiple Engrave Events and place the lower left corner of the box wherever you would like. The numbers and letters you program will always have a standard orientation (like the letters on this page) – you cannot program tilted or inverted letters with the Engrave Event. The letters are of the font shown in the figure and all capitals.

X and Y begin: define the lower left corner position of the first character of the Engrave Event.

Z end: is the depth of the engraving assuming the top of the part is the reference.

Height: the height of each letter or number in the engraving.

Text: tap the Keyboard Info Key and enter the text you want to engrave and press SET.

9.2.14 Thread Mill Event

Thread Mill event enables you to easily program an ID or OD thread.

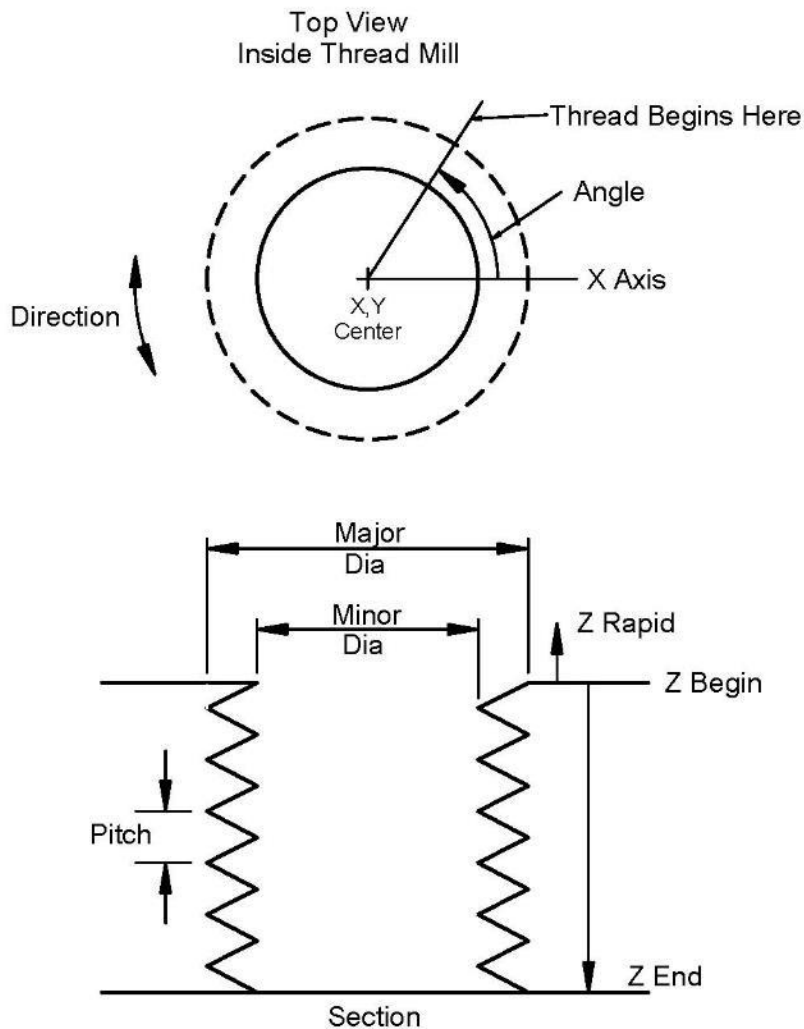

Figure 9.2.14 Thread prompts

Special prompts in the Thread mill event:

Z BEGIN: the Z dimension where the threading pass begins

Z END: the Z bottom of the thread

PITCH: the distance from one thread to the next in inches or mm. It is equal to one divided by the number of threads per inch. For example, the pitch for a 1/4-20 screw is $1 / 20 = .05$ inches

MAJOR DIA: the largest diameter of the thread (the root for an ID thread, the crest for an OD thread)

MINOR DIA: the smallest diameter of the thread (the root for an OD thread, the crest for an ID thread)

SIDE: inside for an ID thread, outside for an OD thread.

ANGLE: the angle the tool feeds into the beginning depth, where the thread begins

DIRECTION: clockwise or counterclockwise

PASSES: - the number of passes to cut the thread to its final depth

9.2.15 Aux Events

Aux Functions allow you to control:

- Coolant

- Air (not available on Euro machines)

- Pulse to interface to a programmable indexer

- Auxiliary Output that is used to interface to some secondary device.

For example, if you wish to have the coolant start when a milling event starts and then turn off at the end, simply insert an Aux event with Coolant On before the milling event and then another with Coolant Off afterwards.

The Accessory button on the Operator Run Keys must be in AUTO for coolant work in your program.

Note: *the coolant will turn off automatically at all tool changes and then back on automatically when the program is resumed.*

9.2.16 Pause

The purpose of the Pause Event is to allow you to program a stop condition within the program. The effect of this event is to stop the program run, turn off the spindle (if you choose, you could leave it on) and move the head to the Z rapid location with the X and Y position corresponding to the end of the previous event.

Pause events are useful if you want to stop the program to make a measurement, change a fixture, etc.

Note: *In general, you should avoid programming a PAUSE event between two connective events. The Pause event will cause the events to NOT be connective.*

To program a Pause Event press the PAUSE soft key. Because there is no input required, simply press SET to load and the event counter will advance by one and the Select Event screen will reappear. You can also choose to leave the spindle on. The default is to turn it off.

In run, restart the spindle and press the GO key after a pause to continue.

9.3 Finishing Teach Events

Teach events are either POSN, DRILL or MILL events that are originated in the DRO Mode (see Section 7.10).

The Teach events that are started in the DRO Mode must be finished in the Program Mode before running. Teach events are of these different types:

TEACH POSN - for two-axis operation, the Position and Drill event types are combined.

TEACH DRILL- this may also be made into a bore or tap event.

TEACH MILL - a straight line that specifies the beginning and the end. When TEACH MILL events are defined using the CONT MILL softkey, the prompts for information that cannot change will be suppressed.

When a Teach event is unfinished, the words NOT OK will appear next to the event type. Once the prompts are completed, the words NOT OK and Teach will disappear. The event will become a normal MILL, DRILL, or POSN event.

10.0 Program Mode Part 3: Irregular Profiles, Pockets and Islands

The powerful Auto Geometry Engine® (A.G.E.)

When you program an Irregular Pocket or an Irregular Profile the Auto Geometry Engine® (A.G.E.) is automatically started.

The A.G.E. is powerful software that works behind the easy-to-use geometry programming of the ProtoTRAK RMX CNC. It is treated in its own section because it works differently than the other event types. Unlike other events, the A.G.E. allows you to:

- Enter the data you know, and skip the prompts you don't.
- Use different types of data (like angles) that may be available from the print.
- Enter guesses for the X and Y ends and centres not available on the print.

With the A.G.E., you can easily overcome limitations in the data the print provides without having to spend time in laborious calculations.

10.1 Starting the A.G.E.

The A.G.E. is started automatically when you enter the Irregular Pocket or Irregular Profile event. The first set of prompts you encounter will be the header information. Complete this first event as you would for any mill event except there is no prompt for X or Y end.

The second event that defines the end point of the first line or arc in the profile must have a known X end and Y end (and X Centre and Y Centre) dimensions. If that is not available on the print, you may be able to enter a ramp on line to the first point. The beginning of this first line would be the point entered in the header (first) event.

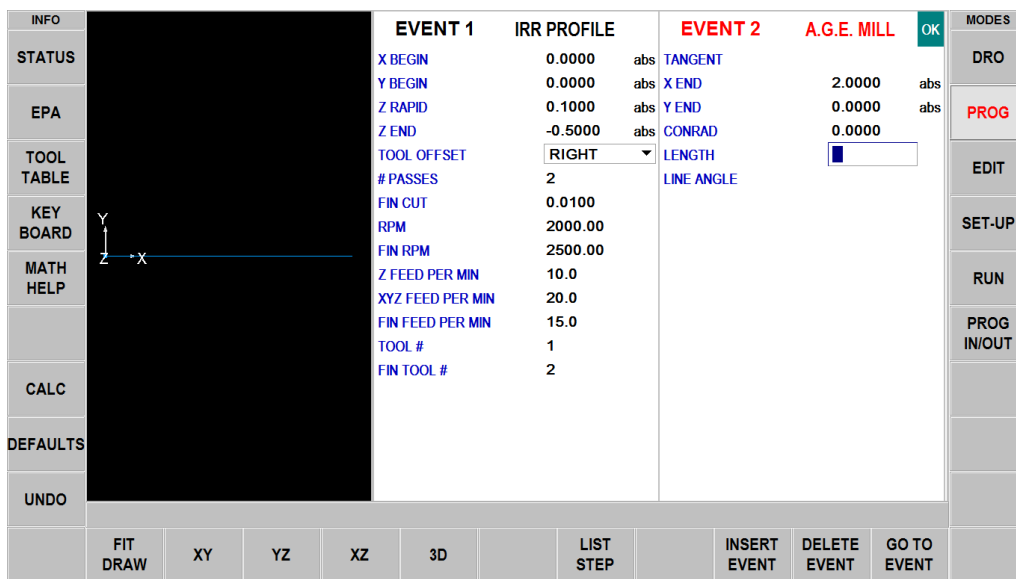

Figure 9.1 Once the header event is complete, you will choose between A.G.E. Mills (as above) or A.G.E. Arcs.

With the header event complete, you'll define the pocket or profile with a series of Mills and Arcs:

A.G.E. Mill: A straight line from one X Y point to another.

A.G.E. Arc: Any part of a circle.

End A.G.E.: Ends the A.G.E. programming for the Irregular Pocket or Irregular Profile.

Abort A.G.E.: Aborts all A.G.E. events. The data for all the events is lost.

10.2 Prompts in A.G.E. Mill programming:

Tangent: this refers to the tangency of the mill to the previous event (Section 10.10).

X END: the X dimension to the end of the mill cut; incremental is X Begin

Y END: the Y dimension to the end of the mill cut; incremental is Y Begin

CONRAD: the dimension of a tangential radius to the next event

LENGTH: the length of the mill from beginning to end.

LINE ANGLE: the angle of this mill line (moving from begin to end) measured counterclockwise from the positive X axis (that is 3 o'clock) (Section 10.10).

GUESS: This softkey will appear when the prompt is on X or Y dimensioned data. Press the Guess key before you press INC SET or ABS SET to enter the data as a guess (Section 10.8).

10.3 Prompts in A.G.E. Arc programming:

TANGENT: this refers to the tangency of the mill to the previous event (Section 10.10).

DIRECTION: the clockwise or counterclockwise direction of the arc

X END: the X dimension to the end of the arc cut; incremental is from X Begin

Y END: the Y dimension to the end of the arc cut; incremental is from Y Begin

X CENTRE: the X dimension to the centre of the arc; incremental is from X End

Y CENTRE: the Y dimension to the centre of the arc; incremental is from Y End

CONRAD: the dimension of a tangential radius to the next event

RADIUS: the radius of the arc

CHORD ANGLE: the angle spanned by the arc (Section 10.11).

GUESS: This softkey will appear when the prompt is on X or Y dimensioned data. Press the Guess key before you press INC SET or ABS SET to enter the data as a guess (Section 10.8).

10.4 Skipping over prompts

In the Auto Geometry Engine®, events don't have to be complete before you can go to the next one. You can skip the data you don't know by tapping the next prompt. You may also simply swipe the event to the left and get started on the next one.

You should always select whether or not the next event is tangent to the previous event (Section 10.10).

10.5 OK/NOT OK

Each A.G.E. event has a flag that tells you if it has been fully defined. Sometimes data from later events is needed to define previous events. To the immediate right of the event type, the words OK or NOT OK appear, depending on whether that particular event is defined.

Once the OK flag appears for the event, you do not need to enter more information. Swipe to the next event.

When the A.G.E. has sufficient data, it will calculate the data needed to fully define the previously NOT OK events. All data calculated by the A.G.E. is shown in red.

10.6 Ending A.G.E.

Any time all the events are of an Irregular Profile are OK, the A.G.E. may be ended.

If you are programming an Irregular Pocket, there is an additional requirement that must be satisfied before the A.G.E. may be ended: the X and Y end point of the last event must be the same as the X and Y beginning point of the first event so that the pocket is closed. Otherwise, the ProtoTRAK RMX CNC cannot program the tool path to clear the pocket.

The Irregular Profile has no such restriction since profiles may be open or closed.

Once the A.G.E. is ended, the Irregular Pocket or Irregular Profile event is complete and you may then choose from all the programming canned cycles from the Select an Event screen.

10.7 Reopening A.G.E.

To reopen the A.G.E. Profile or Pocket, simply use the BACK hard key or swipe to get one of the A.G.E. events on the right side of the screen. You may insert other A.G.E. Mill and A.G.E. Arc events.

10.8 Guessing ends and centres

Whenever you are missing X or Y Ends or Centres, you should generally enter a guess. That is because when the AGE computes X and Y positions it occasionally finds more than one solution. The purpose of guessing is to help AGE decide the correct solution.

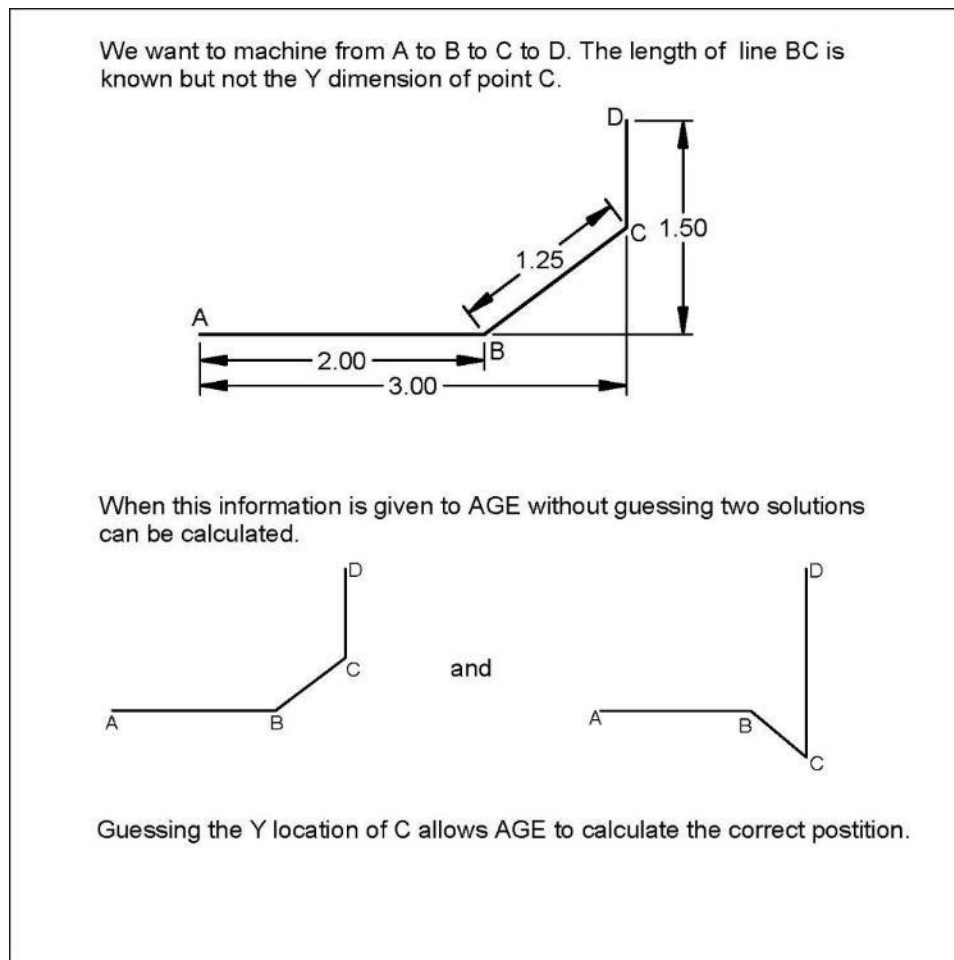

Guess by selecting the GUESS soft key and then tapping the screen drawing approximately where the end or centre point is. Guesses usually don't have to be very accurate unless the part is small and intricate and has multiple solutions close to each other.

Note: When you guess the X End or X Centre, the A.G.E. will also input a guess for the Y dimension. If the Y End or Y Centre dimensions are known, go back and correct the guessed data so that the A.G.E. has more data to work with.

10.9 Calculated Data

Prompts that are skipped or for which guesses are entered may be replaced by data calculated by the ProtoTRAK RMX CNC. Calculated data is shown in red in order to distinguish it from the data that you entered. You cannot edit calculated data, but you may edit your original input. By putting the event with the calculated data on the right side of the screen, you may tap the prompt and re-input the data.

10.10 Tangency

Tangency can occur between a mill and arc or an arc and arc. Specifically it means that the two events share one and only one point and would not cross each other if extended. You would answer yes to the TANGENCY prompt if the event you are programming is tangent to the previous event. The information that events are tangent helps the Auto Geometry Engine calculate other dimensions.

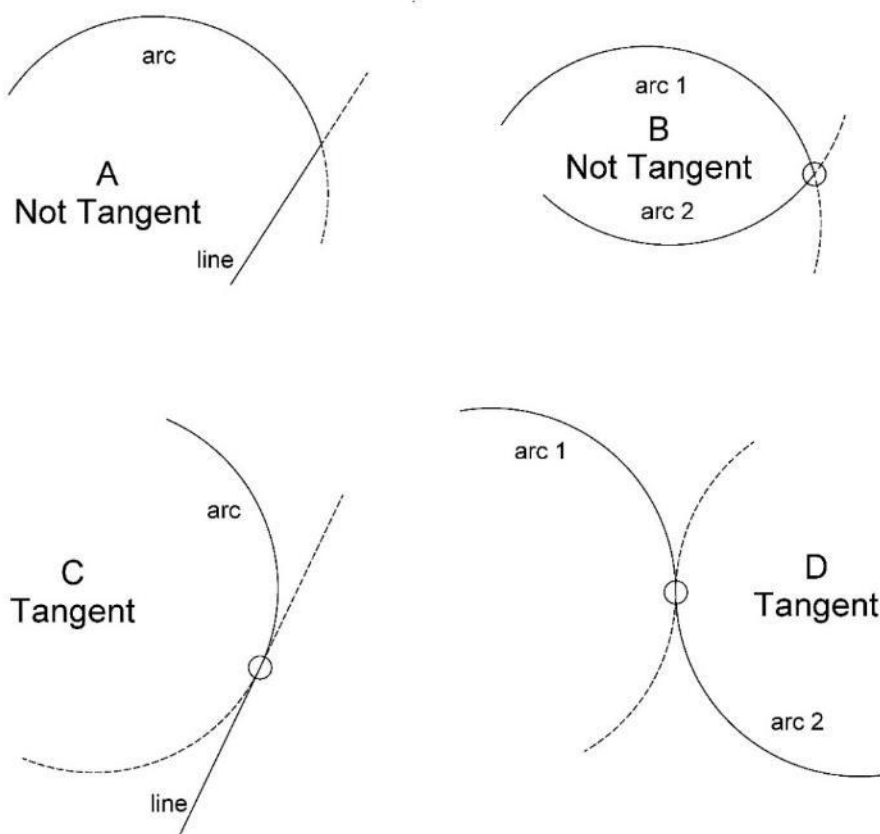

Figure 10.10 Events are tangent when they share one and only one point and would not cross each other if extended.

Refer to Figure 10.10

- A line and an arc or 2 arcs are not tangent if you extend the lines past where they meet and they cross each other. A and B are not tangent.

- A line and an arc or 2 arcs are tangent if you extend the lines past where they meet and they do not cross each other. C and D are tangent

10.11 Line Angle

The Line Angle prompt can be a powerful aid to the A.G.E. in helping you with incomplete print data.

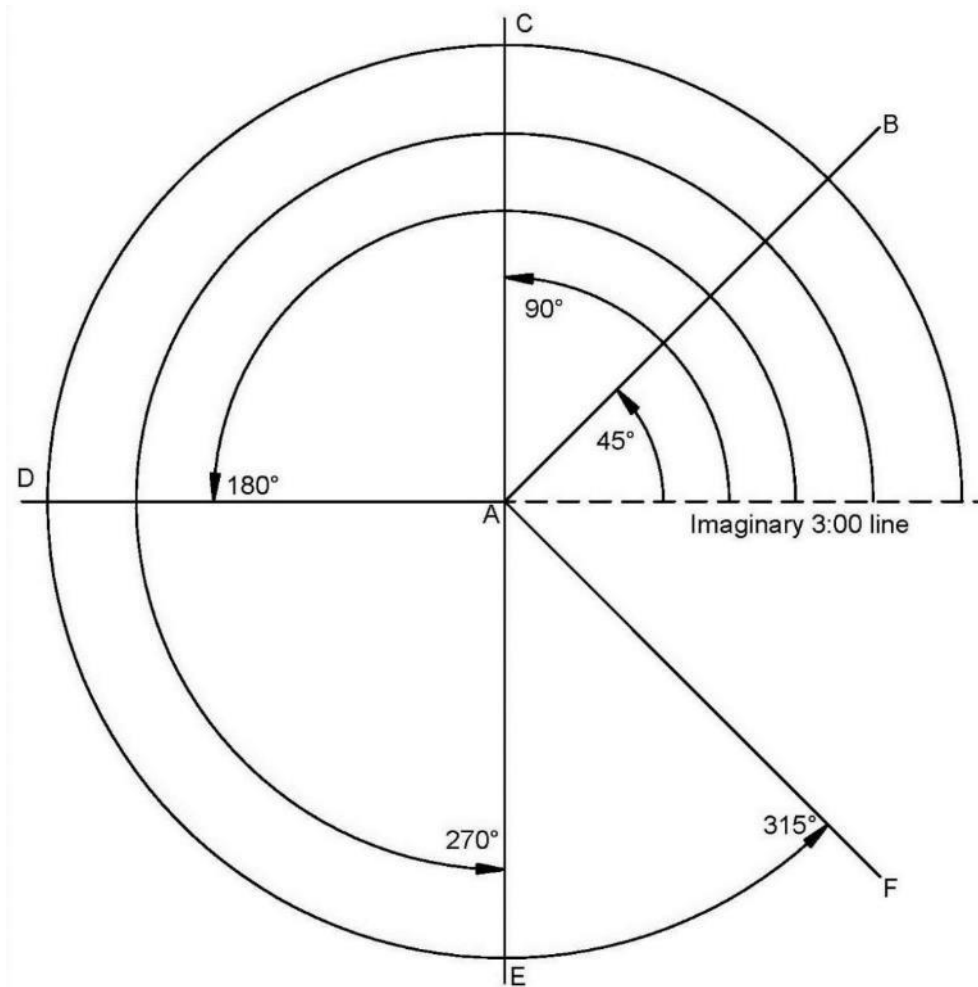

Figure 10.11a Line Angles are referenced from an imaginary line at 3:00.

To measure the angle of an angled line, imagine another line that starts at the beginning of the angled line and extends in the positive X direction or 3:00 o'clock. The line angle is the angle between the imaginary and angled lines always measured positive in the anti-clockwise direction.

In the drawing all lines to be machined from A to B or C or D or E or F and are measured from the imaginary dashed line that starts at A (the beginning) and goes in the positive X direction or 3:00 o'clock. The line angles are shown in the drawing.

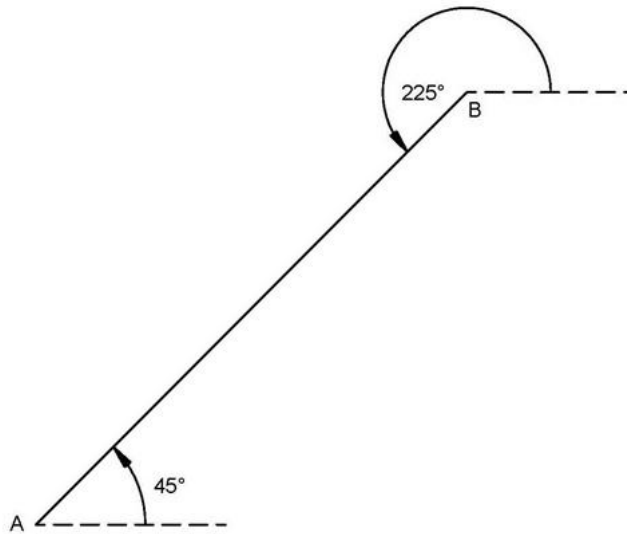

Figure 10.11b The imaginary line is drawn from the beginning of the angled line to be machined.

The imaginary positive X or 3:00 o'clock line must always be drawn from the beginning of the angled line to be machined. Referring to Figure 10.10b above, when machining from A to B, the angle of the line is 45° measured from the imaginary line at A. But when machining from B to A, the angle of the same line is 225° ($180^\circ + 45^\circ$) because B is the starting point and the imaginary line must be drawn from there.

10.12 Chord Angle

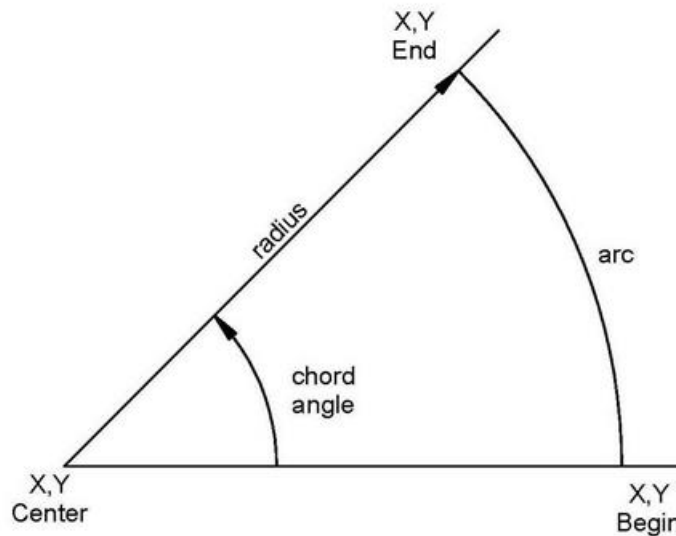
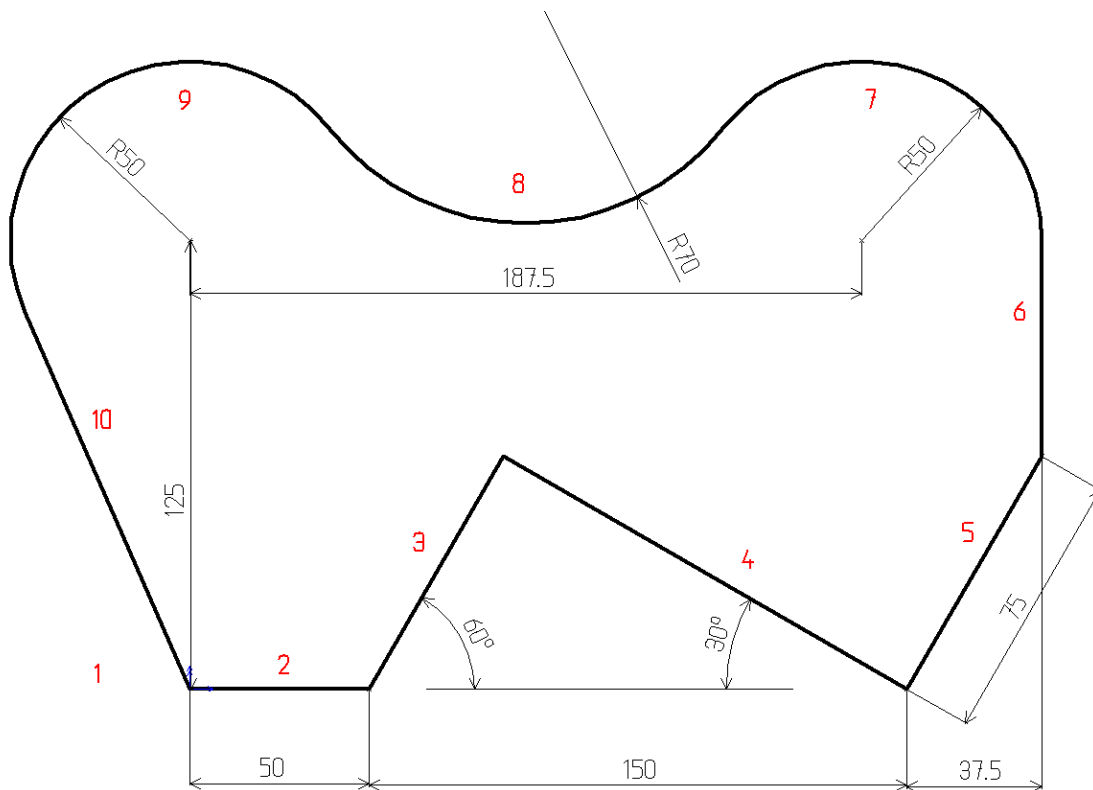

Figure 10.12 The chord angle is measured anti-clockwise.

The chord angle is the angle that is measured anti clockwise as positive from the beginning to the end points.

10.13 Sample A.G.E. program



Consider this profile made up of 9 lines and arcs

Notice what is not known:

- Intersection of lines 3 and 4
- Intersection of lines 5 and 6
- Tangent of arcs 7 and 8
- Centre of arc 8
- Tangent of arcs 8 and 9
- Tangent of arc 9 and line 10

Event 1

The first programmed event is known as the Header. In this sample, this will be Event 1. To begin the A.G.E. you must start by programming the Header and a mill or arc that is fully known, that is, all the needed dimensions are there. The 50mm line segment (2) starting at 0,0 is fully known, so this is where we'll start.

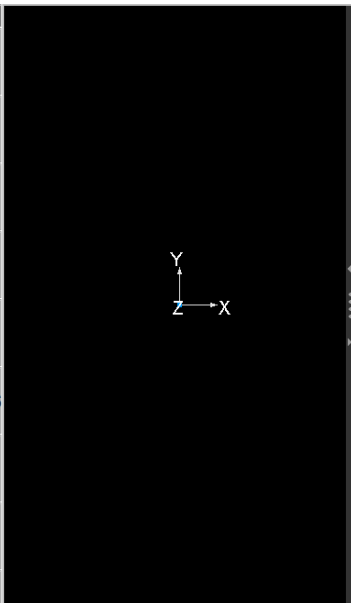
INFO	EVENT 0				EVENT 1			IRR PROFILE	MODES		
STATUS	PROGRAM NAME				SAMPLE1	X BEGIN	0.000	abs	DRO		
TOOL TABLE	SCALE				1.000	Y BEGIN	0.000	abs	PROG		
EPA	MULTIPLE FIXTURES				<input type="checkbox"/> NO	Z RAPID	2.000	abs	EDIT		
MATH HELP	DIMENSION DEFINITION				PART GEOMETRY ▾	Z END	-10.000	abs	SET-UP		
OPTIONS					TOOL OFFSET	1 - RIGHT ▾		RUN			
DEFAULTS					# PASSES	2		FIN CUT	0.250		PROG IN/OUT
KEY BOARD					FIN RPM	2500.00		RPM	3000.00		
CALC					Z FEED PER MIN	500		XYZ FEED PER MIN	750		
					FIN FEED PER MIN	500		TOOL #	1		
					FIN TOOL #	2					
	FIT DRAW	XY	YZ	XZ	3D	LIST STEP	INSERT EVENT	DELETE EVENT	GO TO EVENT		

Complete this first or header event as you would any mill event except there is no prompt for X end or Y end.

Event 2

Select AGE Mill

Input X end (50) and Y end (0) as shown on the screen

There is no CONRAD to the next event

Note the OK label next to the event line

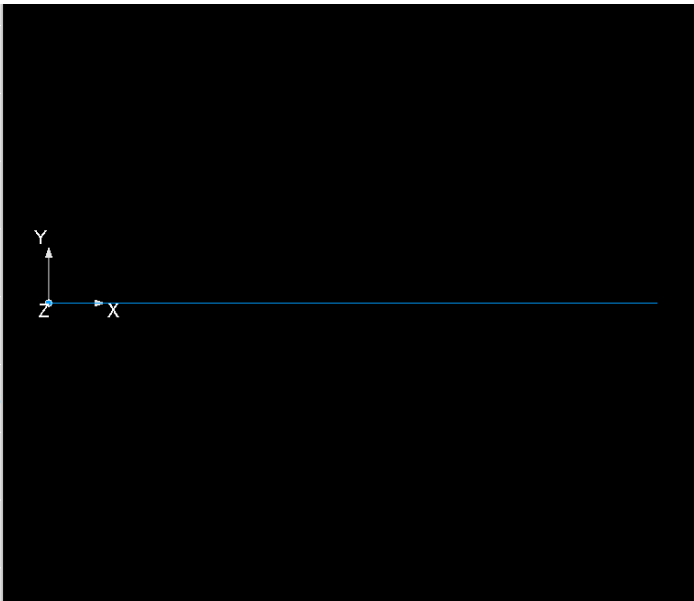
INFO	EVENT 2				A.G.E. MILL	OK	MODES			
STATUS	TANGENT						DRO			
TOOL TABLE	X END				50.000	abs	PROG			
EPA	Y END				0.000	abs	EDIT			
MATH HELP	CONRAD						SET-UP			
DEFAULTS	LENGTH						RUN			
KEY BOARD	LINE ANGLE						PROG IN/OUT			
CALC										
	FIT DRAW	XY	YZ	XZ	3D	LIST STEP	INSERT EVENT	DELETE EVENT	GO TO EVENT	

Event 3

Select AGE MILL

The line in event 3 is not tangent to the line in event 2 (no 2 straight lines can be tangent to each other)
X end and Y end are not known. Tap Guess and select the screen above and to the right of Line 1 for each dimension.

Line angle is 60° measured from an imaginary positive X line from the beginning of Line 2

The line length is not known, skip.

Note NOT OK label. We have input everything we know so swipe to the next event

INFO	EVENT 3	A.G.E. MILL	Not OK	MODES					
STATUS	TANGENT	<input type="checkbox"/>	NO	DRO					
TOOL TABLE	X END	G 52.220	abs	PROG					
EPA	Y END	G 18.504	abs	EDIT					
MATH HELP	CONRAD			SET-UP					
DEFAULTS	LENGTH	60.0000		RUN					
KEY BOARD	LINE ANGLE	60.0000		PROG IN/OUT					
CALC									
	FIT DRAW	XY	YZ	XZ	3D	LIST STEP	INSERT EVENT	DELETE EVENT	GO TO EVENT

Event 4

Select AGE MILL

The line in event 4 is not tangent to the line in event 3.

X end is known (200) and Y end is known (0)

The line angle is 330° measured from an imaginary position X line from the beginning of Line 3 in a counter-clockwise direction

Note this event as well as the previous event are now OK

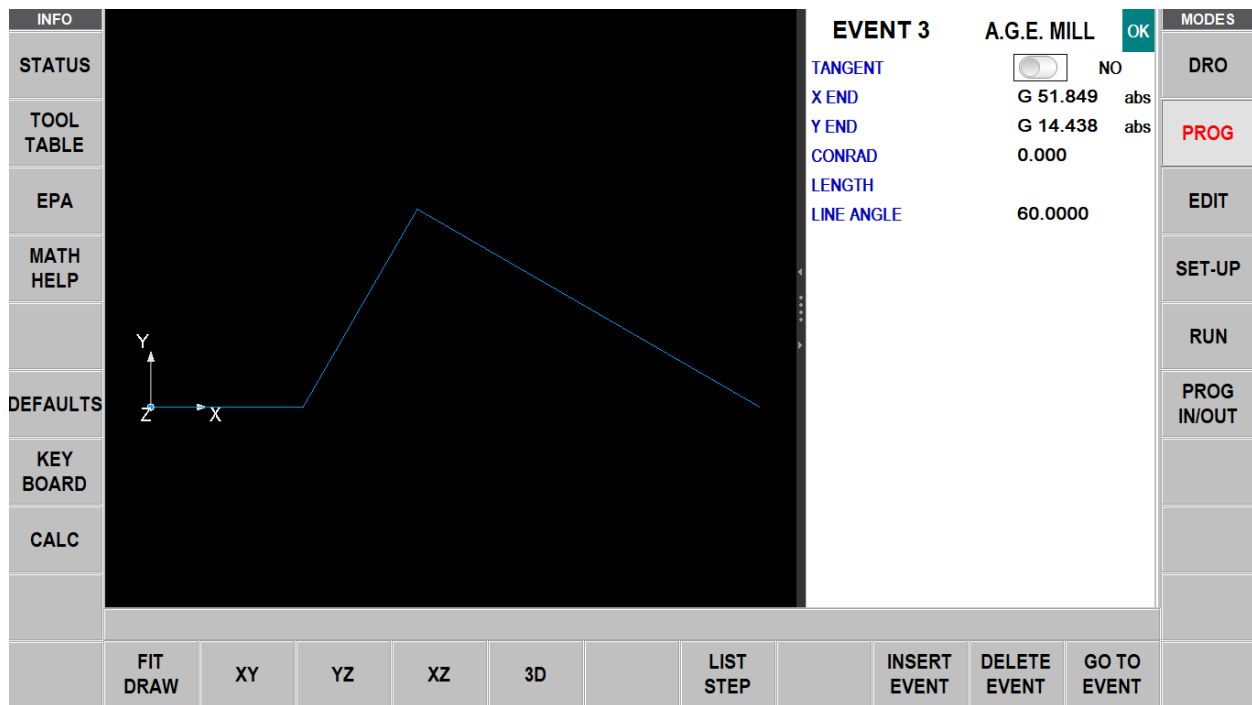

Event 5

Select AGE MILL

X end for line 5 is known (237.5) but Y end is not known. Tap Guess and tap the screen approximately where the Y end is

The 75 length is known

Note the event is OK

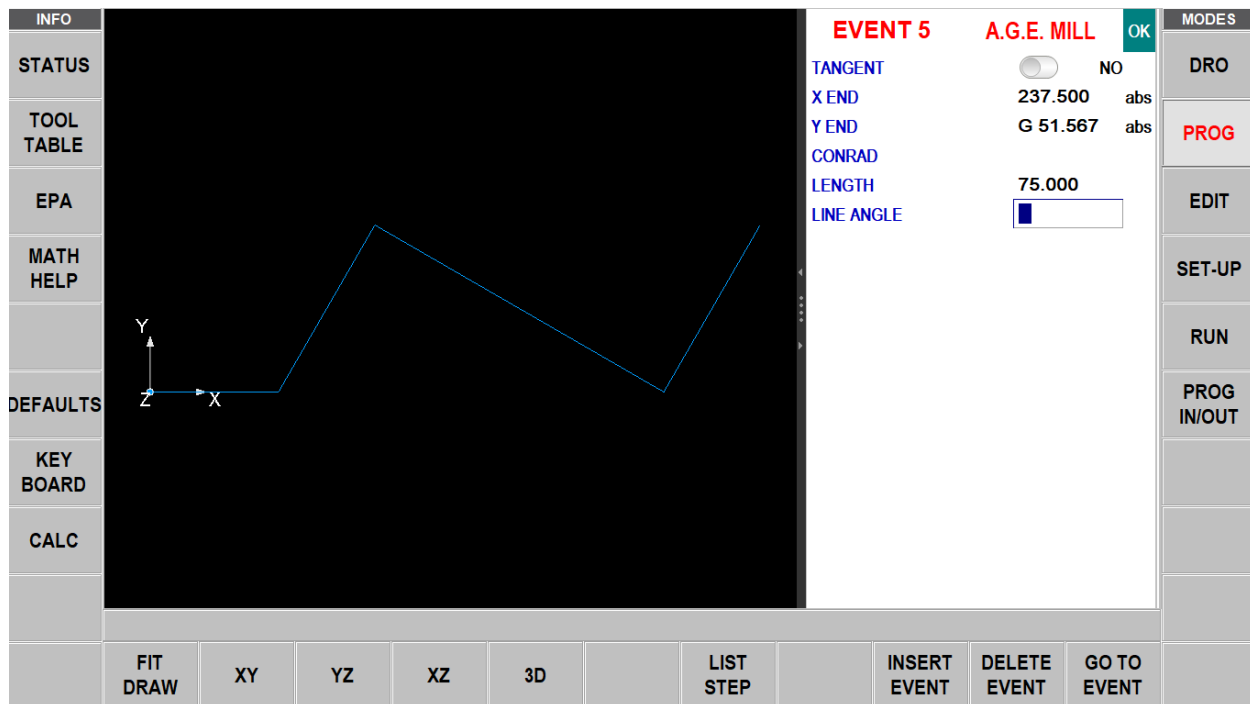

Event 6

Select AGE MILL

The line in event 6 is not tangent to the line in event 5.

X end (237.5) is known and the 125 Y end is known

Note the event is OK

INFO	EVENT 6	A.G.E. MILL	OK	MODES					
STATUS	TANGENT	<input type="checkbox"/>	NO	DRO					
TOOL TABLE	X END	237.500	abs	PROG					
EPA	Y END	125.000	abs	EDIT					
MATH HELP	CONRAD			SET-UP					
DEFAULTS	LENGTH			RUN					
KEY BOARD	LINE ANGLE			PROG IN/OUT					
CALC									
	FIT DRAW	XY	YZ	XZ	3D	LIST STEP	INSERT EVENT	DELETE EVENT	GO TO EVENT

Event 7

Select AGE ARC

The arc is tangent to the line in event 6.

The arc is counter-clockwise

X end and Y end are not known.

X centre at 187.5 and Y centre at 125 are known

The radius at 50 is known

This is all we know. Note NOT OK

INFO	EVENT 7	A.G.E. ARC	Not OK	MODES					
STATUS	TANGENT	<input checked="" type="checkbox"/>	YES	DRO					
TOOL TABLE	DIRECTION	2 - CCW		PROG					
EPA	X END			EDIT					
MATH HELP	Y END			SET-UP					
DEFAULTS	X CENTER	187.500	abs	RUN					
KEY BOARD	Y CENTER	125.000	abs	PROG IN/OUT					
CALC	CONRAD	0.000							
	RADIUS	50.000							
	CHORD ANGLE								
	FIT DRAW	XY	YZ	XZ	3D	LIST STEP	INSERT EVENT	DELETE EVENT	GO TO EVENT

Note the arc is not drawn on the screen at present but by selecting the next feature, the arc will appear on the screen to show the operator the intended feature that has been programmed.

Event 8

Select AGE ARC

The arc is tangent to Arc 7

The arc is machined clockwise

X end and Y end are not known.

X centre and Y centre are not known.

The radius is 70

This is all we know. Note Event 8 is NOT OK and Event 7 is NOT OK yet either

No worry - page forward to next event

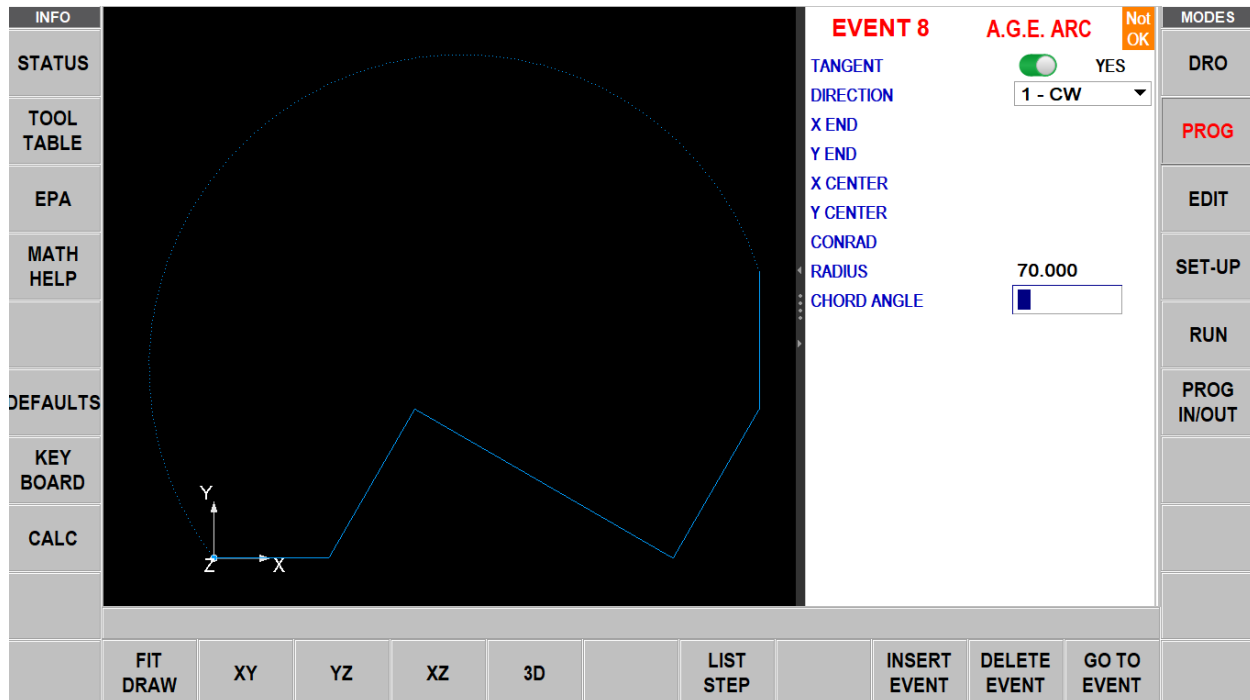

Event 9

Select AGE ARC

The arc is tangent to Arc 8

The arc is machined counter-clockwise

X end and Y end are not known.

The arc centre is known: X centre 0 ABS and Y centre 125 ABS

The radius is 50

Note Event 9 is NOT OK but now Events 7 and 8 can be fully calculated and are OK

Page forward to next event

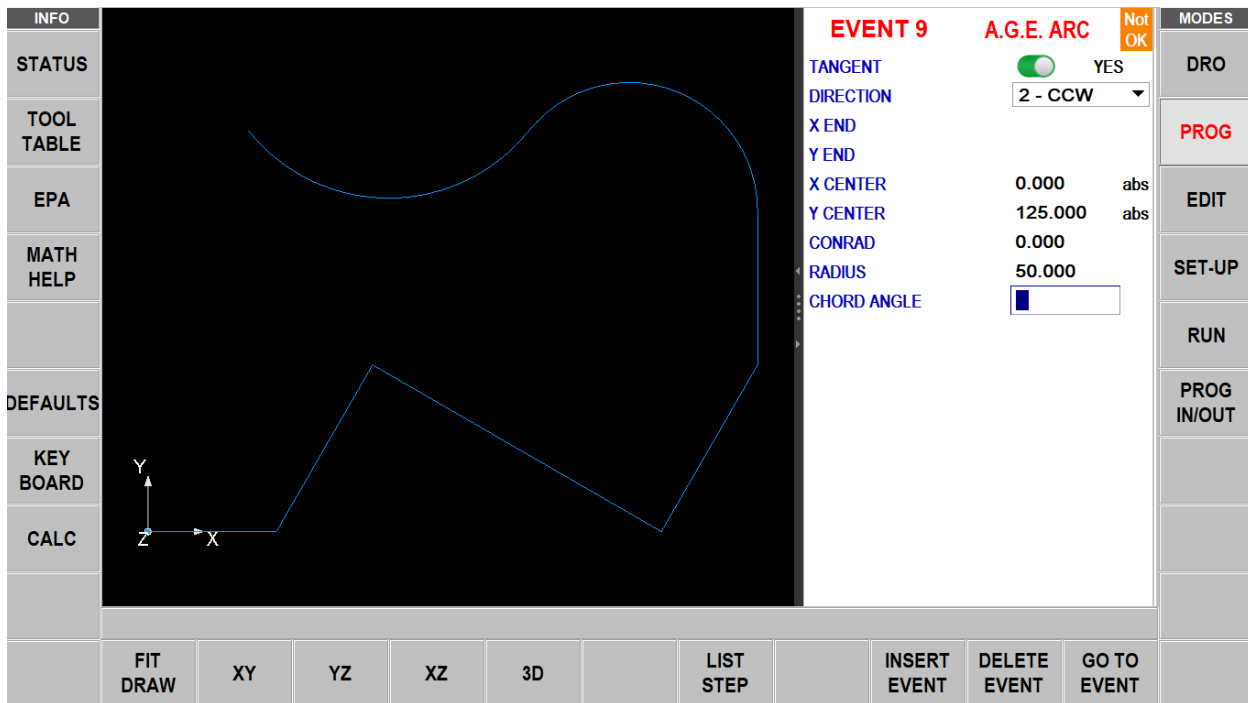

Event 10

Select AGE MILL

Line 10 is tangent to Arc 9

X end at 0.0 and Y end at 0.0 are known

Note Event 10 is OK as well as Event 9

The entire profile has now been programmed

Page forward and tap END AGE

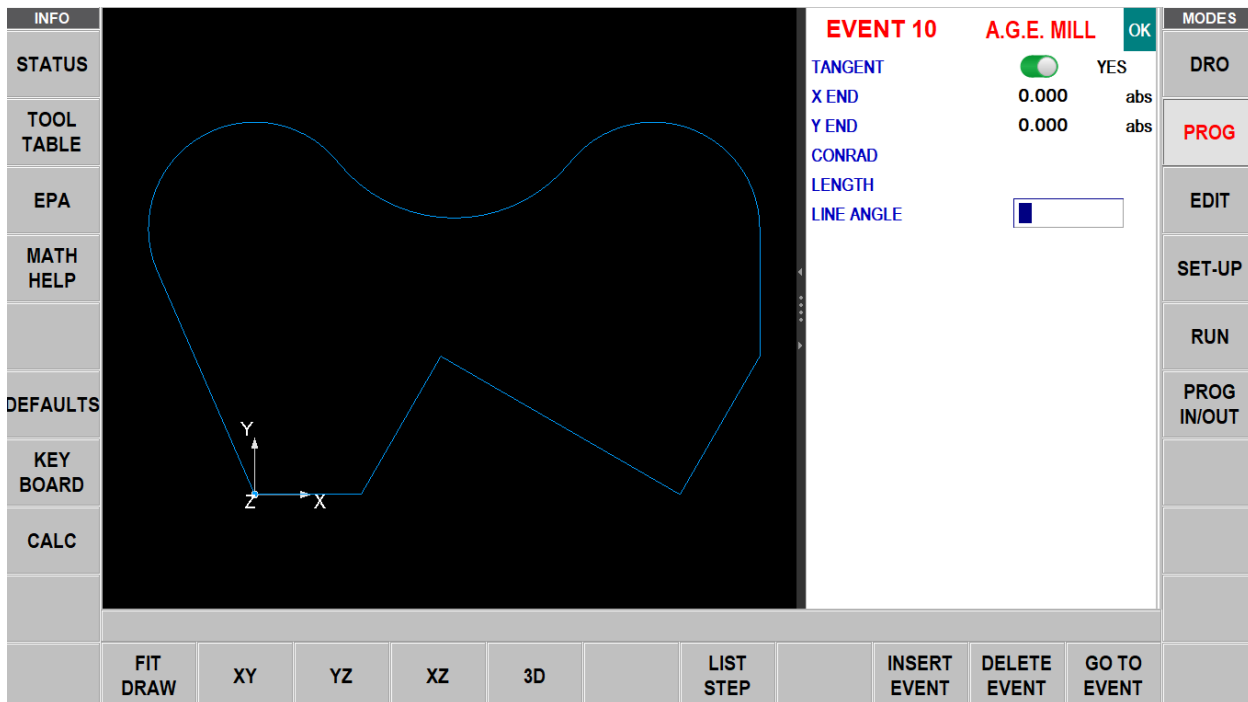

11.0 Edit Mode

Within Program Mode, you can recall and re-input data event by event. In contrast, the Edit Mode contains powerful routines for more extensive program changes.

The changes you make in the Edit Mode affect only the program in current memory. In order to preserve the changes, you must store the program again under the same name in the In/Out Mode.

11.1 Delete Events

Rather than delete one event at a time in Program Mode, you may delete a group of events in the Edit Mode.

In Edit Mode, press Delete Events.

The Data Input Line will prompt for the first event and then the last event to be deleted. Input the event numbers and press SET. The remaining events will be renumbered.

11.2 Search Edit

Selecting Search Edit opens the powerful Spreadsheet Editing function of the ProtoTRAK RMX. Spreadsheet Editing allows you to view program data in a table. From there you can make global changes to the program by selecting which event prompts you want to view, sort or edit. This is particularly useful if you are working with a large program and you need to make changes to many events.

When you press the SEARCH EDIT soft key, the screen will load a table that contains data for the entire program sorted by event number. The first view will show events 1 – 17. Use the Page and Data soft keys, swipe the screen or tap the scroll bar to see other events.

INFO	EV # ▲	TYPE	TOOL #	RPM/SS	FIN RPM/SS	Z FEED	XYZ FEED	FIN FEED	Z RAPID	Z END	MODES
STATUS	1	IRR PROFILE	1	2500.00 R	3000.00 R	500	750	500	2.000 abs	-10.000 abs	DRO
TOOL TABLE	2	A.G.E. MILL									PROG
	3	A.G.E. MILL									EDIT
	4	A.G.E. MILL									SET-UP
EPA	5	A.G.E. MILL									RUN
MATH HELP	6	A.G.E. MILL									PROG IN/OUT
	7	A.G.E. ARC									
OPTIONS	8	A.G.E. ARC									CALC
	9	A.G.E. ARC									
DEFAULTS	10	A.G.E. MILL									PAGE FWD
	11	BOLT HOLE DRILL	2	2500.00 R		500			2.000 abs	-10.000 abs	
KEY BOARD	12	BOLT HOLE DRILL	2	2500.00 R		500			2.000 abs	-10.000 abs	PAGE BACK
	13	CIRC PCKT	3	2500.00 R	3000.00 R	500	750	500	2.000 abs	-10.000 abs	DATA TOP
	14	SUB REPEAT	3								DATA BOTTOM
	TOOL # : 1										GO TO EVENT
											CHANGE ALL
											RETURN

Figure 11.2 The Search Edit key launches powerful Spreadsheet Editing.

Each row in the spreadsheet represents the data for the event number shown in the first column on the left. The event number and event type are always displayed in the first two columns, but the other data displayed on the table can be changed.

Soft Keys in Search Edit:

PAGE FWD: pages forward through the table.

PAGE BACK: pages backwards through the table.

DATA TOP: highlights the data in the first row current sort

DATA BOTTOM: highlights the data in the last row of the current sort

GO TO EVENT: highlights the data in the row of the corresponding event.

CHANGE ALL: enables you to make global changes of data, described below.

Note: the EV# (event number) and (event) TYPE may not be edited in Search Edit so the highlighter will not go there.

11.2.1 Selecting Data to be Displayed on the Search Edit Table

In order to change the data selected in the table, tap the Options info key. You can choose which data to display and the order of the columns by opening or closing the slide bar. Tap Reset to clear all the selections. Tap Options to close and the newly selected prompts will show in the table.

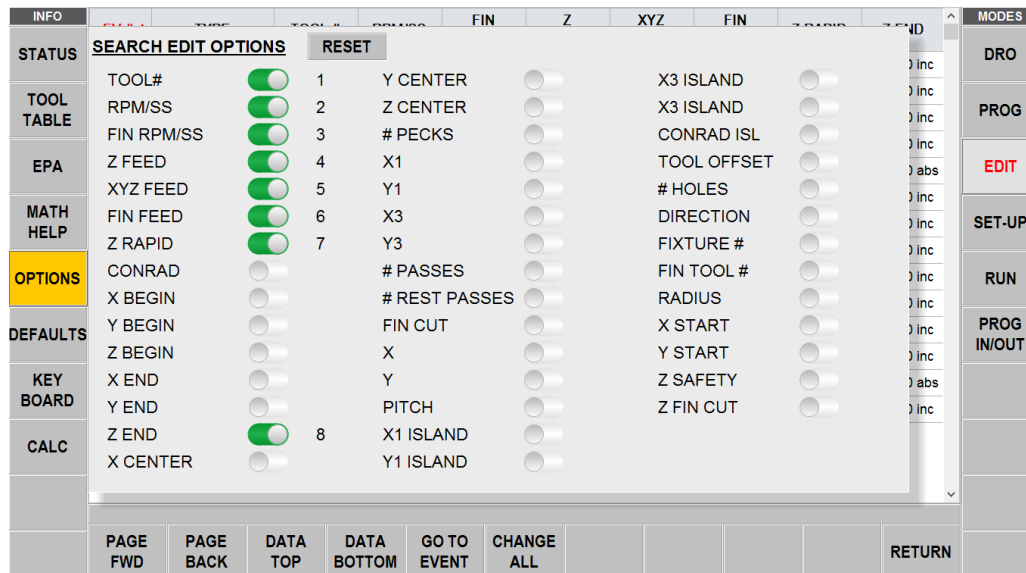

Figure 11.2.1 The Options Info key in search edit enables you to pick the fields to display.

11.2.2 Sorting Data

Data may be sorted by any of the data types displayed in the column head. Red letters show which column is used for sorting the data.

Simply tap the heading of the column to sort its data in ascending order (smallest first) and tap again to change to descending order. The secondary sort will always be Event #.

11.2.3 Making Changes to Data

To edit a single entry tap the entry, input the change and press INC SET or ABS SET.

To edit a group of identical entries:

1. Sort on the entry prompt by tapping the column head. You may sort on any value that gets the data you want to change together.
2. Tap on the first data value you want to change (the highest on the list).
3. Tap Change All.
4. All data values that are the same and below the one you tapped will be highlighted.
5. Input the new value and ABS SET or INC SET. All highlighted entries will be changed to the new value.

The sequence below illustrates changing the # pecks in the program.

INFO	EV # ▲	TYPE	TOOL #	RPM/SS	Z FEED	XYZ FEED	FIN FEED	Z RAPID	Z END	# PECKS	MODES
STATUS	1	IRR PROFILE	1	2500.00 R	500	750	500	2.000 abs	-10.000 abs		DRO
TOOL TABLE	2	A.G.E. MILL									PROG
	3	A.G.E. MILL									EDIT
EPA	4	A.G.E. MILL									SET-UP
MATH HELP	5	A.G.E. MILL									RUN
	6	A.G.E. MILL									PROG IN/OUT
OPTIONS	7	A.G.E. ARC									
	8	A.G.E. ARC									
DEFAULTS	9	A.G.E. ARC									
	10	A.G.E. MILL									
KEY BOARD	11	BOLT HOLE DRILL	2	2500.00 R	500			2.000 abs	-10.000 abs	2	
	12	BOLT HOLE DRILL	2	2500.00 R	500			2.000 abs	-10.000 abs	2	
CALC	13	CIRC PCKT	3	2500.00 R	500	750	500	2.000 abs	-10.000 abs		
	14	SUB REPEAT	3								
# OF FIXED PECKS : 2											
	PAGE FWD	PAGE BACK	DATA TOP	DATA BOTTOM	GO TO EVENT	CHANGE ALL					RETURN

Figure 11.2.3 (a) First, the data is sorted by Event in ascending order to get the bolt hole drill events together and then #pecks in event 11 is selected.

INFO	EV # ▲	TYPE	TOOL #	RPM/SS	Z FEED	XYZ FEED	FIN FEED	Z RAPID	Z END	# PECKS	MODES
STATUS	1	IRR PROFILE	1	2500.00 R	500	750	500	2.000 abs	-10.000 abs		DRO
TOOL TABLE	2	A.G.E. MILL									PROG
	3	A.G.E. MILL									EDIT
	4	A.G.E. MILL									SET-UP
EPA	5	A.G.E. MILL									RUN
MATH HELP	6	A.G.E. MILL									PROG IN/OUT
	7	A.G.E. ARC									
	8	A.G.E. ARC									
DEFAULTS	9	A.G.E. ARC									
	10	A.G.E. MILL									
	11	BOLT HOLE DRILL	2	2500.00 R	500			2.000 abs	-10.000 abs	2	
KEY BOARD	12	BOLT HOLE DRILL	2	2500.00 R	500			2.000 abs	-10.000 abs	2	
	13	CIRC PCKT	3	2500.00 R	500	750	500	2.000 abs	-10.000 abs		
	14	SUB REPEAT	3								
CALC											
# OF FIXED PECKS : 2											
											RETURN

Figure 11.2.3 (b) Next, tapping the Change All soft key highlight all the same #pecks from event 11 and down.

INFO	EV # ▲	TYPE	TOOL #	RPM/SS	Z FEED	XYZ FEED	FIN FEED	Z RAPID	Z END	# PECKS	MODES
STATUS	1	IRR PROFILE	1	2500.00 R	500	750	500	2.000 abs	-10.000 abs		DRO
TOOL TABLE	2	A.G.E. MILL									PROG
	3	A.G.E. MILL									EDIT
	4	A.G.E. MILL									SET-UP
EPA	5	A.G.E. MILL									RUN
MATH HELP	6	A.G.E. MILL									PROG IN/OUT
	7	A.G.E. ARC									
	8	A.G.E. ARC									
OPTIONS	9	A.G.E. ARC									
DEFAULTS	10	A.G.E. MILL									
	11	BOLT HOLE DRILL	2	2500.00 R	500			2.000 abs	-10.000 abs	4	
	12	BOLT HOLE DRILL	2	2500.00 R	500			2.000 abs	-10.000 abs	4	
KEY BOARD	13	CIRC PCKT	3	2500.00 R	500	750	500	2.000 abs	-10.000 abs		
	14	SUB REPEAT	3								
CALC											
# OF FIXED PECKS : 4											
PAGE FWD	PAGE BACK	DATA TOP	DATA BOTTOM	GO TO EVENT	CHANGE ALL						RETURN

Figure 11.2.3 (c) Finally, the # pecks was changed to 4 in all the events from event 5 and down by pressing 4, SET.

11.3 Erase Program

Use the ERASE PROG soft key to erase the program from the current memory. Erasing the program from current memory will not affect any programs that are stored.

If you have made changes to the program and wish to save this modified program, you will need to store it. See Section 14.4.

11.4 G-Code Editor

The G-Code Editor allows the edit of G-Code programs that are opened as .GCD files. Once edited, the program may be re-saved as .GCD files. ProtoTRAK Geometry-style programs may not be saved as .GCD files.

When you enter the G-Code Editor, the G-Code program is displayed starting at the first Block Number. Use the scroll bar to move up and down through the program. Search allows you to launch a simple find-and-replace routine to aid in editing large G-Code files.

Click in the Find What box and enter the item you want to find. Click on the Find Next box and the G-Code Editor will locate the next occurrence of that item. Use Match Whole Word to limit the search to the entire word. For example, if you want to find G2, but not G20 or G22, select Match Whole Word Only.

To make changes to Find What items, type what you want to have into the Replace With box. You can replace items one at a time by clicking first the Find Next box then the Replace With box for as many changes as you want to make. You can replace every item in the program with a single click of the Replace All box.

Return closes the G-Code Editor and returns the screen to the Edit Mode.

Note: *If you use the USB Thumb Drive to store a G-code (.gcd) program file, you must leave the Thumb Drive plugged into the USB port the entire time the program is in current memory. If you unplug the thumb drive with the program still in current memory, the ProtoTRAK will display an error message.*

11.5 Clipboard (Advanced Feature)

The Clipboard feature is a way to copy events in one program in order to put them into a different program. It is a two-part process that takes place in two different Modes. First, in the Edit Mode, the desired events are copied, or placed on the Clipboard, from the source program. Then the events are inserted into the destination program in the Program Mode.

When you press the Clipboard key from the Edit Mode, you start the process that copies the events that you want to put into a different program than the one in current memory.

Before you do that, you should write a program or open the program file that has the events you want to copy. This is called the source program.

Inspect the events you want to copy. Make sure that the dimensioned data uses Absolute references in the first event to be copied and in all events where it will be important. Incremental references may be used, but keep in mind where the Incremental reference will be made from. See the section on Incremental Reference Position in this manual.

In addition, you may want to modify this program in order to get all the events you want together. For example, if you want to copy events 2-5 and 7-12, you may want to modify the program to delete events 1 and 6 first. That way, you can copy the all the events as they are now numbered from 1 to 10. Remember that you can modify this program just for this purpose and it will not affect the original program unless you save it with the modifications in the Program In/Out Mode.

When the source program is ready, press the CLIPBOARD softkey. A message will appear that says "Copy Events Onto Clipboard" and the Data Input Line will read "From Event". Enter the number of the first event that you want copied and press SET.

The Data Input Line will read "To Event". Enter the number of the last event you want copied and press SET.

The group of events that you have specified is now on the clipboard and will remain there until you replace it with something else by going through the same procedure. When power is turned off to the CNC the clipboard information will also be lost.

The events on the clipboard are inserted into a program in the Program Mode. See Section

12.0 Set-Up Mode

12.1 Tool Path

When the TOOL PATH soft key is pressed, the program is processed and the tool path graphics are displayed. Large programs will take longer to process.

At the completion of running Tool Path, a time will appear in the upper left hand corner of the screen with the estimated time to run the program.

Since tool changes are manual, no time is allocated for the time required to change tools.

Most programming errors that would prevent the program from running are detected when the tool path graphics are selected. The displayed graphic is automatically sized to fit the screen and an icon that represents the X, Y and Z orientation is placed at the program's absolute 0 reference point. The path shown on the screen represents the centre of the tool.

- Position and drill events are drawn in yellow.
- Rapid moves are in red.
- Programmed feeds are in blue.

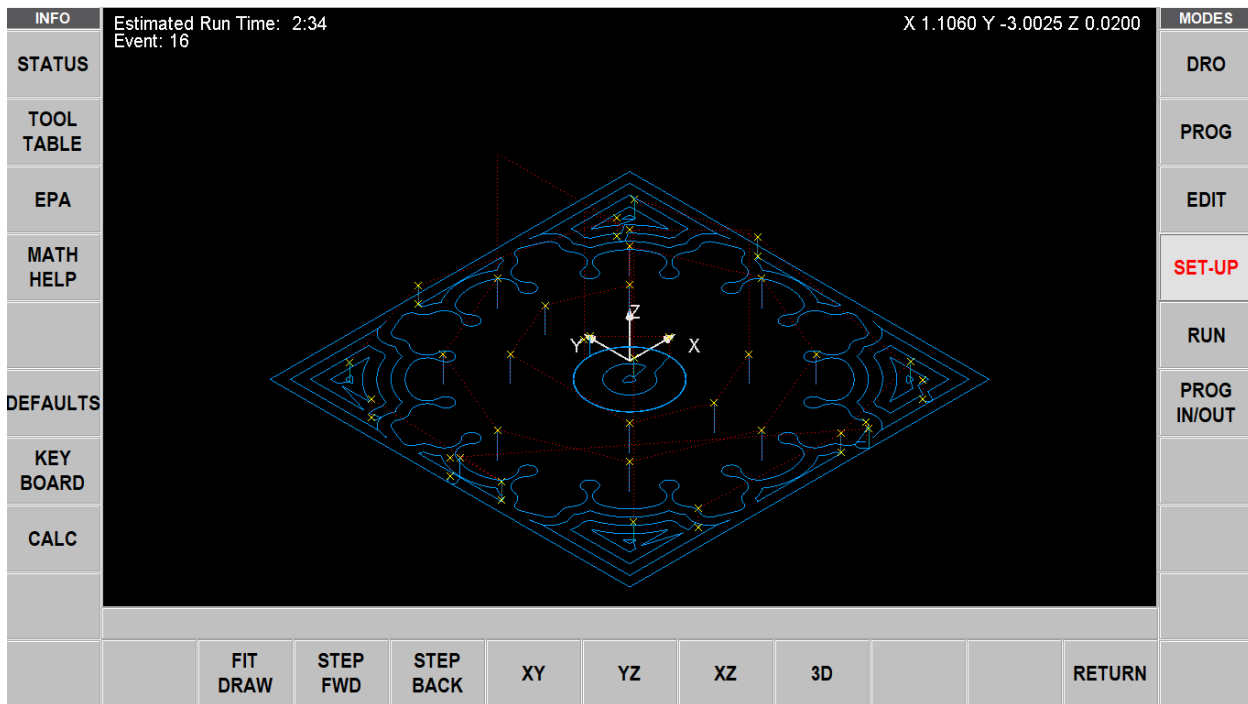

Figure 12.0 The ProtoTRAK RMX processes the program and then displays the tool path.

When the drawing is displayed you may spread or pinch to zoom in or out. You may also pan up, down or sideways.

Soft Keys in Tool Path

FIT DRAW: will re-draw, automatically sizing to fit the screen (necessary only if an adjustment changed the drawing from its initial sizing).

STEP FWD: each press of the STEP FWD button shows the next tool move. To complete the drawing automatically, press FIT DRAW.

Tap STEP to move through the path one move at a time. The move you are on will be shown in purple.

XY, YZ, XZ, 3D: shows the same drawing on the screen, with adjustments, in the view you select.

STEP BACK: each press of the STEP BACK button moves backward in the program 1 move.

Note – each step forward or backward shows the X, Y and Z coordinate of that move.

RETURN: returns to the previous soft keys, retaining the adjustments that were made to the drawing.

12.2 Reference Positions (REF POSN)

The Reference Positions screen shows the retract status, the home locations and software limits for all axes.

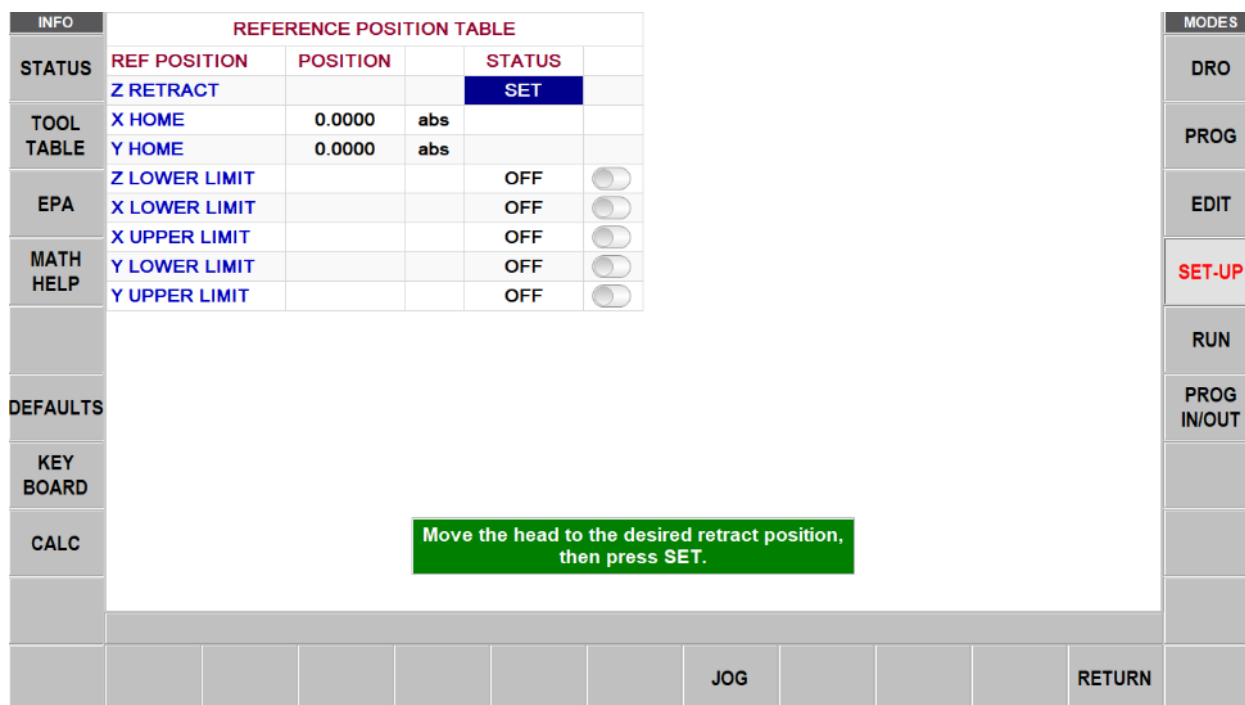

Figure 12.2 The reference positions in Set Up Mode.

12.2.1 Z Retract

The Z Retract is where the head will go for a tool change or at the end of running a program. Programs may not be run in three-axis CNC until the Z Retract is set. Since the Z-axis (head) is operated manually in two-axis CNC, it is not necessary to set the Z retract to run a two-axis CNC part.

As a general rule, always set your Z retract so that your longest tool is above the set-up.

When you first enter the Reference Positions screen, the Z Retract will show "NOT SET" and the message window will instruct you to move the head to the desired retract position and then press SET. You may jog the head by pressing the Jog soft key.

12.2.2 Home Positions

X and Y home positions are where the table and saddle go when there is a tool change or at the end of the program. These dimensions must always be from absolute zero. Note Z home is the same as Z Retract.

12.2.3 Limit Positions

X and Y limit positions (one for plus direction, one for minus) will stop the program if they are exceeded during run. Note that pressing the LIMIT ON/OFF soft key will turn the prompted limit off, or back on to its input value. If the limits are turned on, your program and home positions must fit within the limits you define. If you turn on the limits and leave them at the default of 0 Absolute, the program will not run.

12.3 Fixture Offsets

Fixture offsets are entered in the Set-Up Mode.

Setting up fixtures is easy. First, establish your base by setting your X, Y and Z absolute zero. You can do this in the DRO Mode, but the X, Y and Z Absolute position dimensions are also on this screen for your reference. Fixture #1 is always the base.

Once you set your absolute zero on the base, it is a simple matter of entering the distance from the base to up to five other fixture locations. You can do this one of two ways. By entering the numbers with the keypad or by positioning to the next fixture, tapping the offset value, and then pressing ABS SET.

The ERASE TABLE button is used to erase all fixture offsets from the table.

12.4 Verify Part (Advanced Features Option)

Verify Part is used to see a solid graphical representation of the tools making the part. There is no better way to see how your tool and part will interact than to see the solid model and tool represented in Verify. Of course you must define the diameter of your tool along with your type of tool (finish end mill, ball end mill, drill, etc.) you are using when setting up your tools in tool setup. This allows you to draw the correct shape for the tools you are cutting with.

Press VERIFY PART and the following soft keys will show:

DEFINE STOCK: if you wish to input dimensions of your rectangular stock relative to the programmed absolute zero.

You don't necessarily have to define the stock because Verify will automatically calculate and define the stock based on the G code generated to run the program. The Z top and bottom value Verify calculates will be based off of the largest Z positive and negative value that is in the program. This means if you program a drill to go through the part it will make this value the Z bottom value.

By using Define Stock you can put in the actual stock size and therefore get a more accurate picture of the interaction between the tool and the part.

Note – the stock size you end up with is saved with your program.

AUTO: will have Verify recalculate the stock for you.

Press MAKE PART and the display shows your stock material.

The status line shows whether simulation is on or off, the speed of the verification, the status of STOP or GO and the tool number for the tool that is being simulated. The speed can be adjusted from single stop all the way to a value of 20. The default speed is set to 1. Press the speed up or down buttons to adjust your speed. When on the single step speed, pressing GO will step the tool through each step of the program.

The first 4 soft keys are used to adjust the part view and can be tapped before the simulation or during the simulation when the tool is cutting the part.

VERIFY PART will launch the solid graphic part verification routine as shown below. A Yellow progress bar will appear as the simulation of the tool path takes place. After the tool path simulation finishes, the part will be drawn as it will appear after machining.

SHOW PART: will skip the tool path simulation and show the finished part.

SPEED UP and SPEED DOWN: adjusts the speed of the tool path simulation.

STOP: Stops the tool path simulation

EXIT: exits the verification and returns you to the DEFINE STOCK page.

Verify in 2 Axis

When using VERIFY software in 2 axis mode on a 3 axis products, Verify will set the stock size in Define Stock to 0 since there is no Z information in your program. By default, we will make the part 25mm thick when showing the material. Manually enter Z information in Define Stock to get a good representation of the part.

12.5 Service Codes

These are special codes that may be entered into the ProtoTRAK RMX CNC to call up routines used in installation, setting of preferences, machine checkout and service.

WARNING!

Before using service codes, be aware that some of the routines are very powerful and may change important system settings. Some of the routines cause the servos to come on and move at rapid speed.

The Service Codes are divided into logical categories. The table below summarizes the more important ones. See the service manual for more information on using Service Codes.

12.5.1 Software

Code	Description	Comment
33	Software, Firmware and PLC versions	Displays current software versions and system settings.
141	Load configuration file from USB thumb drive	To load configuration files from a USB thumb drive to the RX control.
142	Save configuration file to USB thumb drive	To save the configuration files for reloading later. When a computer replacement is necessary, saving the settings to a thumb drive for reloading them later is highly desirable.
316	Update Software	Runs the routine that copies new software from a USB thumb drive device to the ProtoTRAK system. Use this routine to install new ProtoTRAK software.
318	Converter and Software Options	Displays which software options are turned on. Options in bold letters mean the option is active.

12.5.2 Machine Set-Up

Code	Description	Comment
11	Hysteresis	Measures the backlash between motor encoders and glass scales.
122	Axis Calibration Using Offset	This is a scale factor (one per axis) that is defined as the length of the part programmed divided by the physical dimension of the actual part measured. It is less than 1 for a part that was cut too big and greater than 1 for a part that was cut too small.
123	Calibration Mode	Use to calibrate the RMX control with a standard. Note – when you have glass scale option, we calibrate both the motor and glass scale at the same time.
128	Backlash Calibration Constant	Use to load backlash compensation for each axis.
304	Toggle Sensor/Glass Scale On or Off	Turn on or off
308	Reverse EHW Direction	Change direction of Electronic Hand Wheel on X axis or Y axis

311	Run Machine With Spindle Off	Allows the user to run a program on the machine with the spindle off. This normally would be something a service technician might want to do more so than a user.
312	Toggle Limit Switches On or Off	Turns limit switches on or off
321	Reverse Y Position Sensor	Reverse the direction of the glass scale
322	Reverse X Position Sensor	Reverse the direction of the glass scale
325	Reverse Quill Position Sensor	Reverse the quill sensor or glass scale.
338	Toggle Limit Switches from 1 to 2 input	Tells software which style limit switch is present.
400	Update Foreign Language MLS File	Used to update the software language table. Please contact your distributor for available languages and for more information.
510	Spindle Setup and Calibration	Allow for calibration of the spindle
530	Set Pendant and Machine Serial Numbers	Service code to record pendant , computer module and machine serial numbers. A warning will be given to user until this requirement is met.
540	Disable File Based Write Filter	This service code must be used when changes need to make to the operating system. When networking the control or loading drivers, this service code must be run.

12.5.3 Diagnostic Codes

Code	Description	Comment
1	Program, Configuration File, Log Back up	The following service code captures all important data from the RX machine. This includes the user's program, configuration files, message log, fault log etc. This is used to help us solve problems that may pertain to the software. This file can then be emailed to our service department.
54	Continuous Run Mode	Cycles through the program in current memory.
81	Program Panel Keyboard Test	Gives a tone feedback to a button push and highlights the button.
131	Manual DRO	Turns off servos so you can check encoders. Shows motor encoders and glass scale counts and direction of counts.
132	Electronic Handwheel Test	Test the EHW signals
314	Toggle Test Indicator (Debug Lights)	Turns on diagnostic lights to help troubleshoot certain problems.
319	Message Log	Logs the machine as it runs. It captures all key presses, error messages and data as the machine runs. It is saved automatically with service code 1.
320	Fault Log	A log that captures all faults and error messages.

Code	Description	Comment
326	Look Up Message	Allows user to display safety flashing messages, master messages and slave error messages on screen.
327	Display Memory Check	Displays memory availability of various devices
521	Check Control IO (input/output)	Application used to check all machine input and outputs.

12.5.4 Operator Defaults/Options

Code	Description	Comment
79	Turn On/Off Beeper	Turn the beeper on or off
143	Spindle Stays on at Tool Change	Allows the spindle to stay on at a tool change.
328	EPA On/Off	Turns the EPA feature on or off

12.5.5 Lube Pump Codes

Code	Description	Comment
300	Lube Pump Switch Discharge	Allows the user to manual discharge the lube pump
301	Set Lube Pump Cycle Time	Sets the time in minutes between pumping cycles
302	Set Lube Pump Discharge Time	Sets the time in seconds for how long to pump for each cycle.

13.0 Run Mode

13.1 Run Mode Screen

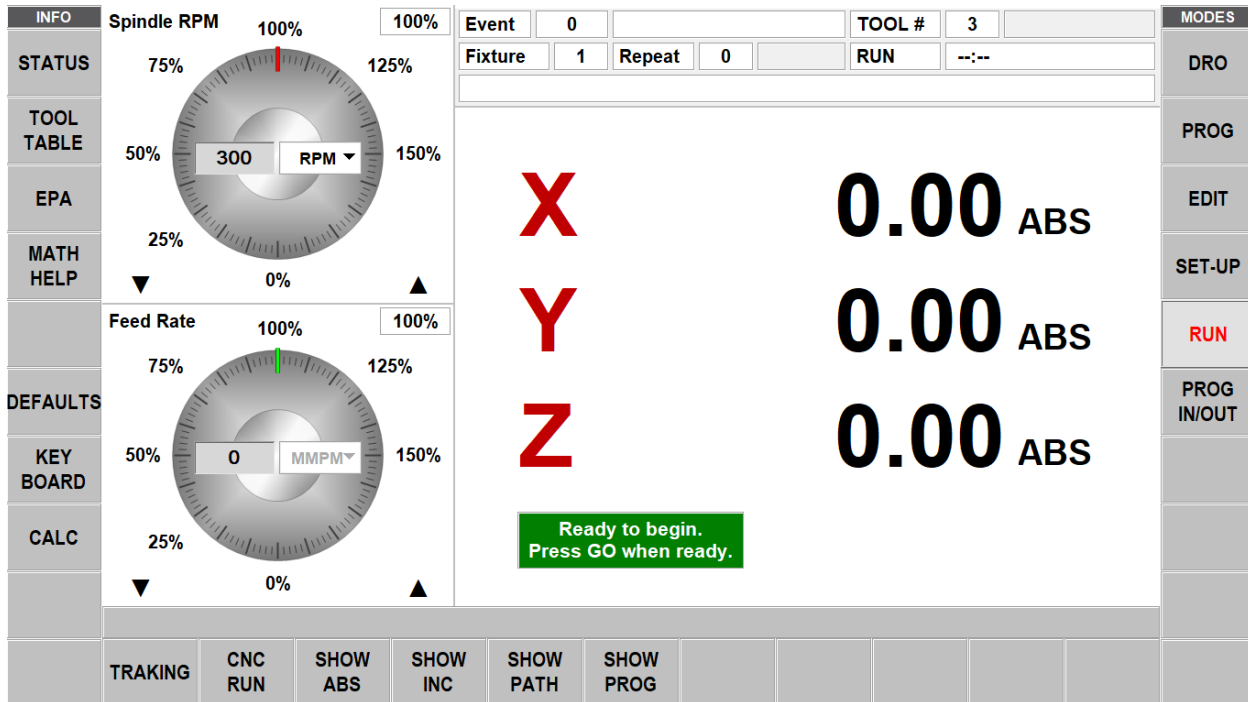

New items on the Run Screen:

Event counter: this will be the current event number and event type.

Repeat: if a repeat event is in the event counter, this will show which repeat number, for example, if you program a drill with 5 repeats, this will show which repeat of the event that is being machined.

Tool #: the current tool number to load when prompted

Fixture: the fixture where machining will begin

Run: Shows RUN or TRAKing when in TRAKing mode. The box to the right shows the runtime clock. This does not count the time for a manual tool change. You must first run tool path in setup mode.

13.2 Starting to Run

Before running a part, you must establish the position relationship between the part and spindle. That is, you need to identify where the part is on the table relative to the tool or spindle centerline.

This is done by using an edge finder or dial indicator to move the table so that the part program absolute zero is under the spindle centerline. **ABS SET** this position as absolute zero in the DRO mode. In addition, load the tool for Event 1 and position it at Z absolute zero. If this is impossible, position the tool some known distance above absolute zero and **ABS SET** this dimension.

The program may be started in two ways:

START: Begins the program at Event 1 and assumes that the absolute zero that was last set in the DRO mode corresponds to the part program zero. That is, if you were in the DRO mode and you moved the table to X=0 ABS, and Y=0 ABS the part program zero would be directly under the quill centerline.

START EVENT #: Allows you to start in the middle of a program. When appropriate, you will be prompted to identify the repeat number you wish to begin or select between beginning at the Rough, Rest or Finish Tool. In addition to this, you can start at a certain pass # or at the XY, Z or XY and Z finish cut.

13.3 Program Run

SHOW ABS: the absolute X, Y, Z positions as the part is run.

SHOW INC: the incremental (or distance to go within the event) X, Y, Z positions as the part is run.

SHOW PATH: the tool path graphics as the part is run.

SHOW PROG: the programmed data for the event being run, and the next event as the part is run.

The run procedure is very simple. Follow the instructions in the green message box and proceed by pressing the GO key.

At the beginning of a program or once the STOP hard key is pressed, additional softkeys will be available:

TRAKing: tap this softkey to control the X, Y and Z programmed motion with the table or saddle handwheel. The TRAKing/Electronic Handwheels Option must be active for this function.

CNC Run – tap this softkey to start the CNC run

The screenshot displays the CNC control interface. On the left, there are two gauges: Spindle RPM (set to 300 RPM) and Feed Rate (set to 6350 MMPM). The center displays absolute positions for X, Y, and Z axes, all showing 0.00 ABS. A green instruction box in the center reads: "LOAD TOOL #1, 10.00 DIA. Rough End Mill START SPINDLE PRESS GO FOR CNC RUN OR PRESS TRAKING". The right side of the interface shows a table of programmed data and a vertical menu of softkeys including DRO, PROG, EDIT, SET-UP, RUN, and PROG IN/OUT. The bottom of the screen features a row of softkeys: TRAKING, CNC RUN, SHOW ABS, SHOW INC, SHOW PATH, and SHOW PROG.

Event	2	A.G.E. MILL	TOOL #	3
Fixture	1	Repeat	0	
			RUN	--:--

13.4 TRAKing/ Electronic Handwheel Option

The TRAKing / Electronic Handwheel feature is optional for all RMX models.

TRAKing is a special kind of CNC run. When you tap the TRAKing soft key, the programmed head, table and saddle motion are controlled by turning the table or saddle electronic handwheel. Moving the X or Y handwheel in the clockwise direction moves forward through the program; moving anti-clockwise moves backward through the program. The spindle must be on in order to TRAK once the head reaches the programmed Z Rapid position. To TRAK slowly, use the Y handwheel. To TRAK quickly, use the X handwheel.

TRAKing comes in handy whenever you are a little unsure about any aspect of your program or set-up. For example, on the first run of a part - instead of pressing GO and holding your hand on the stop button, use TRAKing to bring the tool to the part while you watch the DRO. Once assured that everything is all right, press STOP and get into CNC run.

13.4.1 TRAKing in Two-Axis CNC

When running the ProtoTRAK RMX as a two-axis CNC, TRAKing works with the manual operation of the Z or head. The tool may be put in position when the messages "Set Z" or "Check Z" appear.

13.5 Program Run Messages

While in the Run Mode, clear instructions and prompts from the RMX CNC will tell you exactly what to do to run the program. These messages will appear in a green box in the middle of the screen.

When a tool change is required, the tool information entered in the Tool Table will appear in the green box.

Any Event Comments you entered during programming will appear in the box directly above the XYZ Dimension readouts. The Event Comments feature is part of the Advanced Features Option.

Once the program starts, a Run Time Clock will appear near the top of the screen. This clock displays the time remaining until the end of the program or the next tool change, and will count down as the program is run.

Note: the program must first be viewed as Tool Path in the Set Up Mode to initialize the Run Time Clock. Otherwise it will show 0.00.

13.6 Stop

At any time, the program may be halted by pressing the **STOP** key. This freezes the program at that point. You may choose to continue running the program by tapping the CNC RUN softkey or pressing the **GO** key. You may also run the program by using the Electronic Handwheels on the table or saddle by tapping the **TRAKing** softkey.

13.7 Chip Clear

Whether or not you are using CNC Run or the (optional) TRAKing, you will have the Chip Clear option available once the running commences. Chip Clear is a handy way to interrupt the cutting and move the tool up and out of the part. You may also move the X & Y axis to a desirable location by using jog or turning the handwheels. You may stop the spindle if desired. When you are ready, tap RESUME and the tool will move back where it left off when you tapped CHIP CLEAR. X&Y will move to the previous location first, and then Z will come down to where you left off. When you hit the RESUME button, you can use CNC RUN or TRAKing to move back down into the part.

13.8 Feedrate and Speed Overrides

In program Run Mode, the programmed XYZ axis feeds as well as the rapid speeds may be adjusted. Likewise, the programmed spindle speed may be adjusted.

See Sections 7.3 and 7.4 for using the Graphical Spindle and Feed Rate Override.

14.0 Program In/Out

The Program In/Out Mode is where you work with those programs you want to store, or receive from others.

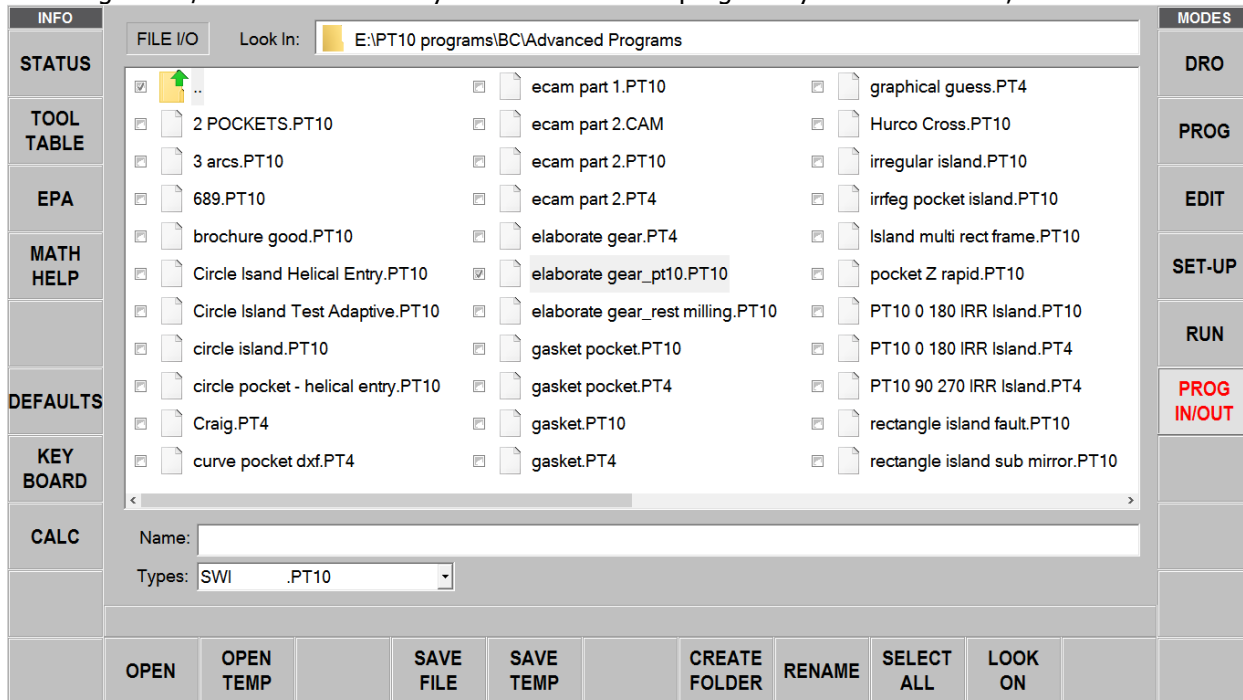

Figure 14 The Program In/Out screen showing a few of the programs used to test the ProtoTRAK RMX before release.

14.1 Getting to files and directories.

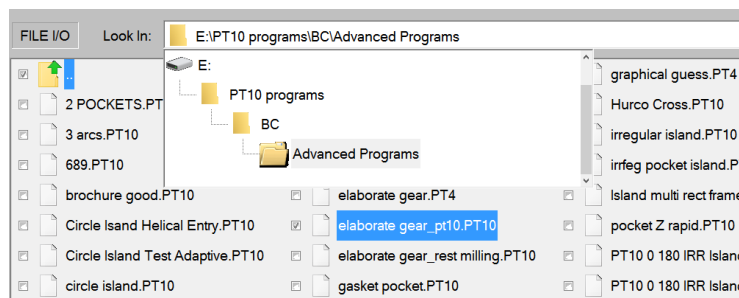

Figure 14.1 Tap in the Look In box to see the available drives. Above, the file path is also shown for the highlighted program.

When you tap into the Look In box, the ProtoTRAK RMX will give you a view of the available drives. Tapping on the drive you want will expose its file structure in the main part of the screen. To open a drive, simply tap on the drive you want. Double tap the folder name or tap the Open soft key to open folders.

The Name box will display the name of the program in current memory until you highlight another folder or program.

The Types box will show which file types are displayed. If you purchased optional Converters, you will see the appropriate file type extension listed when you tap in the Types box. For example, if a DXF Converter is installed on the ProtoTRAK RMX, you will see the .DXF and .DWG extensions.

Thumb drives and Network locations are assigned to Drives D, E, F, etc. as you add them.

Note: Although you may view the contents, the ProtoTRAK RMX will not allow programs to be saved to the C Drive. You must use either a USB Thumb drive or Network to save and retrieve saved programs.

14.2 Saving a program

To save a program you have written or edited, we recommend you do the following steps in order:

- In PROG IN/OUT – open the folder in which you want to save the program.
- The Program Name defined in the PROG mode will automatically be in the Name bar. When you press SAVE FILE, that file will be saved and should appear in the open folder.
- Otherwise, you can click on the text box next to Name, and use the keyboard to type in your program name.

If you want to save a copy of the file under a different name, simply tap in the Name bar and the Key Board will automatically launch. Erase the old name and then enter the new name. Close the Key Board and tap SAVE FILE.

14.3 Opening a saved program.

To open a program, navigate to the one you want and then tap on it to highlight. Then either double tap on the file name or tap the OPEN soft key.

The ProtoTRAK RMX will only keep one program in current memory at a time so you will be reminded that opening a new program will overwrite the one in current memory.

Tip: if you made changes to the program in current memory, save it again before opening another one.

When the new program is loaded into current memory, the ProtoTRAK display will revert to the startup screen.

The LOOK ON soft key will show you an XY line drawing of the program as you highlight them. If the program is large, the ProtoTRAK RMX may take a moment to display the drawing.

14.4 Temp files.

Temp files enable you to preserve the set up information for the part you are working on, in addition to the program. This is handy in case you would like to shut down the ProtoTRAK without losing the offsets, reference position and other information you need to run the program. You may also want to use Save Temp periodically as you are working if you are worried about losing power. It is three taps from programming to Save Temp and then back to where you were in the program.

All programs, tools and position info will be saved at the moment you tap Save Temp. Tapping Save Temp over-writes all data from previous Save Temp.

Tap Open Temp to restore all the information to the ProtoTRAK RMX.

Tip: After Open Temp, it is wise to check X, Y, Z ABS zero in case something moved!

14.5 Deleting a program or folder

To delete a program or folder, press (not tap) and hold file name or folder in the data section until you see the highlighted circle, when you pick up your finger you will see the drop down box. Press DELETE. You will be warned before deleting.

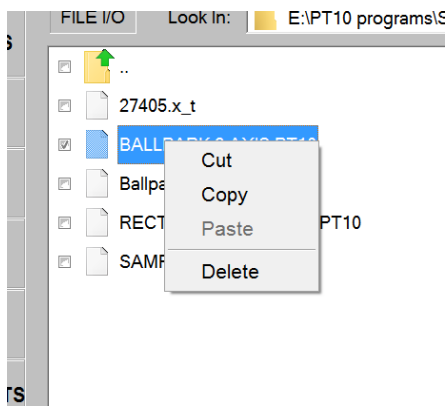

Note: to delete the program from current memory, go to Edit Mode, Erase Prog.

14.6 Renaming a program or folder.

To rename a program or folder from Program In/Out, first navigate to the item you would like to rename. Tap and highlight the Name box.

You will first need to erase the current name. Tap the Keyboard info key to launch the keyboard. Once it appears, tap into the Name box again so that what you do on the keyboard will be shown in the Name box.

Press Rename. The name of the file or folder will change. The old name will disappear (that is, you do not create a copy with a new name, leaving the old name as it was previously saved.)

14.7 Create a new folder.

To create a new folder, first highlight the drive or folder in which you want to have the new folder.

Launch the Keyboard by tapping the Keyboard info soft key. Then tap into the Name box. If there is a name already there, use the backspace of the keyboard to erase the name. The item with that name will not be affected.

Use the keyboard to write the name of the new folder. Press Create Folder and a new folder with the name in the Name box will appear.

14.8 Copy or Cut a file or folder

To copy a file or folder, first navigate to the drive and double tap the folder where the program you want to copy is located.

Press (not tap) and hold file name or folder in the data section until you see the highlighted circle, when you pick up your finger you will see the drop down box.

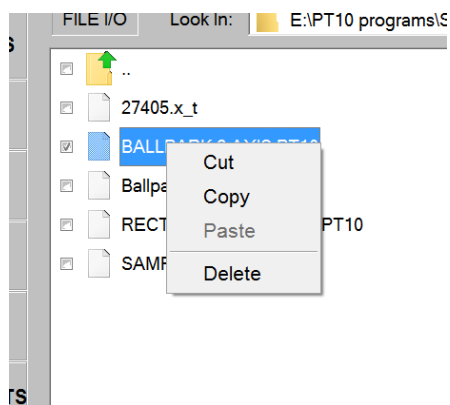

Figure 14.8 Pressing and holding the file name will bring up the box as shown above.

Tap Copy to copy the item. Tap Cut to have the item deleted from the original location.

To place the copied item in a new location first navigate to the location where you want the copy to go. Press and hold this drive, folder name or screen within the folder as above and select Paste.

If you selected Copy originally, the file or folder will not be deleted from the first location. If you selected Cut, it will be deleted from the first location.

14.9 Backing Up Programs

You may do a backup using the procedure above. When you tap the Select All soft key, all the files and folders visible on the screen will be selected. By pressing Copy, you may place these files into a new location all at the same time.

Note: if you select a large number of files, the ProtoTRAK RMX may need a moment to perform the copy and paste.

14.10 Look On

Press the Look On button to enable a preview window on the left hand side of the screen. This will dynamically show you a top view of the program that is highlighted on the right hand side of the screen. Press the Look Off button to disable the preview window.

14.11 File extensions

Programs you write on the ProtoTRAK RMX will automatically receive the file extension .PT10. The following is a list of other program types and what will happen if you open them.

Extension	Description	Notes
.PT10	ProtoTRAK RX series	RMX files created and files converted and then saved.
.PT4	ProtoTRAK SM, VM, SMX & TMX	Some feature incompatibility.
.MX2	ProtoTRAK MX2 & AGE2	Some feature incompatibility.
.MX3	ProtoTRAK MX3 & AGE3	Some feature incompatibility.
.GCD	G-code Program	Will run as a G-code file
.CAM	G-code Program	to be converted to ProtoTRAK format
.DXF	a DXF file	Optional DXF converter will launch when the file is opened.
.DWG	an AutoCad DWG drawing file	Optional DXF converter will launch when the file is opened.
.X_T	Parasolid model file	Optional Parasolid converter will launch when the file is opened.

14.12 Supported G codes for CAM converter

Open a G code file as a CAM file in order to convert it into an event program. Doing so will gain the advantage of being able to edit the program easier, such as using our Search Edit feature.

G Code	Description	Acceptable Format	Notes
G00	Position at maximum feedrate	G00 X0.0 Y0.0 Z0.0	
G01	Linear Interpolation	G01 X0.0 Y0.0 Z-10. F150	F = Feedrate in mm per minute
G02	Circular Interpolation (Clockwise)	G02 X1. Y20. Z0. I0. J20. K0.	I, J, & K define the X, Y, & Z centerpoints respectively, incremental from the starting point of the arc.
G03	Circular Interpolation (Counter-clockwise)	G03 X20. Y0. Z0. I20. J0. K0.	
G20	Input in Inch	G20	
G21	Input in Metric	G21	
G40	Cutter compensation cancel	G40	
G41	Cuttter compensation left	G41	
G42	Cutter compensation right	G42	
G54	fixture offset 1 (Base offset)	G54	Note that this only calls out which fixture # is being used. Fixture Offsets (much like tool offsets) are defined conversationally at our control.
G55	fixture offset 2	G55	
G56	fixture offset 3	G56	
G57	fixture offset 4	G57	
G58	fixture offset 5	G58	
G59	fixture offset 6	G59	
G73	Peck drilling cycle – Chip Break Peck	G73 X0. Y0. Z-10. R1 Q3 F150	Q = depth of peck
G80	Canned cycle cancel	G80	
G81	Drilling cycle	G81 X0. Y0. Z-10. R1 F150	Z = final depth R = rapid position
G82	Drilling cycle, dwell at bottom	G82 X0. Y0. Z-10. R1 P500 F150	P = dwell time in milliseconds
G83	Peck drilling	G83 X0. Y0. Z-10. R1 Q3 F150	Q = depth of peck
G84	Tapping cycle	G84 X0. Y0. Z-20. R1 S300 F150.	For machines with programmable spindle only. S defines RPM, Pitch = F / S
G85	Boring cycle	G85 X0. Y0. Z-10 R1 F150	
G89	Boring cycle, dwell at bottom	G89 X0. Y0. Z-10 R1 P800 F150	P = dwell time in milliseconds
G90	Absolute programming	G90	
G91	Incremental programming	G91	
M00	Pause / Program Stop	M00 (Set Z)	The comment within the parenthesis will be displayed in a green message box.
M05	Spindle Off	M05	
M06	Tool Change	T1 M06	
M07	Mister On	M07	

M08	Coolant On	M08
M09	Coolant Off	M09
M21	Indexer pulse - beginning of event	M21
M38	Mister Off	M38
M51	Auxiliary Output On	M51
M53	Auxiliary Output Off	M53

14.13 Supported G codes for GCD programs

Open a G code program as a GCD file in order to run the program as is. The advantage here is being able to run much larger files.

G Code	Description	Acceptable Format	Notes
G00	Position at maximum feedrate	G00 X0.0 Y0.0 Z0.0	
G01	Linear Interpolation	G01 X0.0 Y0.0 Z-10 F150	F = Feedrate in Inches per minute
G02	Circular Interpolation (Clockwise)	G02 X1. Y20. Z0. I0. J20. K0.	I, J, & K define the X, Y, & Z centerpoints respectively, incremental from the starting point of the arc.
G03	Circular Interpolation (Counter-clockwise)	G03 X20. Y0. Z0. I20. J0. K0.	
G06	Helix (Clockwise)	G06 X0. Y0. Z0. I10. J0. K0. D2.0	K defines the centre point in Z of the first revolution. D defines the # of revolutions.
G07	Helix (Counter-clockwise)	G07 X0. Y0. Z0. I10. J0. K0. D2.0	
G17	Select XY Plane	G17	G17 - G19 only apply to G2 and G3.
G18	Select XZ Plane	G18	
G19	Select YZ Plane	G19	
G20	Input in Inch	G20	
G21	Input in Metric	G21	
G40	Cutter compensation cancel	G40	
G41	Cuttter compensation left	G41	
G42	Cutter compensation right	G42	
G54	fixture offset 1 (Base Offset)	G54	The offset difference from each other is defined conversationally on our control.
G55	fixture offset 2	G55	
G56	fixture offset 3	G56	
G57	fixture offset 4	G57	
G58	fixture offset 5	G58	
G59	fixture offset 6	G59	
G61	Exact Stop movement	G61	Will feed into exact position at intersection points before proceeding to next event. May hesitate briefly.

G64	Blending movement	G64	Will blend intersection points together for smoother motion.
G80	Canned cycle cancel	G80	
G81	Drilling cycle	G81 X0. Y0. Z-10. R1 F150	Z = final depth, R = rapid position
G82	Drilling cycle, dwell at bottom	G82 X0. Y0. Z-10. R1 P500 F150	P = dwell time in milliseconds
G83	Peck drilling cycle – Fixed Peck	G83 X0. Y0. Z-10. R1 Q3 F150	Q = depth of peck
G83	Peck drilling cycle – Variable Peck	G83 X0. Y0. Z-10. R1 I3 J1 K1 F150	I = Initial peck amount J = Minimum peck K = Amount to reduce each peck by
G84	Tapping cycle	G84 X0. Y0. Z-20. R1 S300 F150	For machines with programmable spindle only. S defines RPM, Pitch = F / S
G85	Boring cycle	G85 X0. Y0. Z-10 R1 F150	
G89	Boring cycle, dwell at bottom	G89 X0. Y0. Z-10 R1 P800 F150	P = dwell time in milliseconds
G90	Absolute programming	G90	
G91	Incremental programming	G91	
G98	Return to initial point in canned cycle	G98	
G99	Return to R point in canned cycle	G99	
M00	Program Stop (prompts for "Press Go")	M00	
M02	End of Program	M02	
M05	Spindle Off	M05	
M06	Tool Change	T1 M06	
M07	Mister On	M07	Not available for Euro
M08	Coolant On	M08	
M09	Coolant Off	M09	
M21	Indexer pulse	M21	
M30	Program End	M30	
M38	Mister Off	M38	Not available for Euro
M51	Auxiliary Output On	M51	
M53	Auxiliary Output Off	M53	

14.14 Networking

Prior to networking your control, you'll need to turn off the File Based Write Filter temporarily, as follows:

14.14.1.1 Press Mode, Setup, Service Code, input 540 and press ABS Set. When the following screen comes up, press Yes.

INFO	CODE 540 - Disable File-Based Write Filter	MODES
STATUS	When the File-Based Write Filter is enabled, Windows will always revert back to the original state it was in when it left the factory. It only saves important files necessary for our software to function properly. FBWF helps protect the Windows OS and hard disk from possible corruption, viruses, and malware. It also minimizes the writes to the hard disk, which in turn extends its life cycle.	DRO
TOOL TABLE		PROG
EPA	This service code will disable the File-Based Write Filter and then reboot your system. Please make sure to save your program in memory before running this service code.	EDIT
MATH HELP	After the system reboots, the control will be in a state where our software will not launch normally, but allow the user to go into Windows and make whatever changes he wants to become permanent. This should be used for the purpose of making changes to network settings, installing new drivers, or remembering new devices that are plugged into the ProtoTRAK control.	SET-UP
DEFAULTS	Once you have made the changes you want, simply click on the FINISHED button, and the system will save all the changes and then reboot one more time. Afterwards, the system should launch normally, with the File Based Write Filter enabled.	RUN
KEY BOARD		PROG IN/OUT
CALC	<div style="background-color: green; color: white; text-align: center; padding: 5px;"> RESTART NEEDED Choosing this operation will require you to restart your machine. Do you wish to continue? </div>	
	<div style="display: flex; justify-content: space-around;"> YES NO </div>	

14.14.1.2 The machine will reboot and bring you to the Windows desktop. Here you'll make your changes, then once your changes are made, click Finished as shown below to reboot (Note, if you fail to click finish and reboot, you'll return to this screen. The RX software will not open up automatically on this screen)

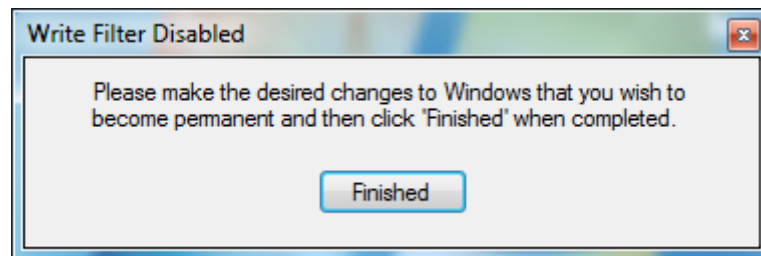

14.14.1 Networking – Windows 7

Networking Requirements:

- Setting up the RMX/RLX on a Workgroup for Windows 7
- Straight thru CAT 5 / Ethernet Cable
- Mouse & Keyboard plugged into the RX controller
- Local Admin rights to the PC
- Obtain a DSL Cable router with DHCP Services
- All clicking on the mouse will be done with left button (left click) unless specified to right click

Basic Peer to Peer Network Utilizing Workgroup

1. In order to establish a Workgroup Network in Windows 7, the computer and control must have the same workgroup name in order to be able to communicate with each other. You'll need to check the Workgroup name on your PC and if you wish to, modify the name as well and then adjust it on the RX side to match in order to be able to network the two together. To do this, perform the following steps:
 - a. On your keyboard, press the Windows Logo Key to bring up the Start Menu, locate and right click Computer, then click Properties

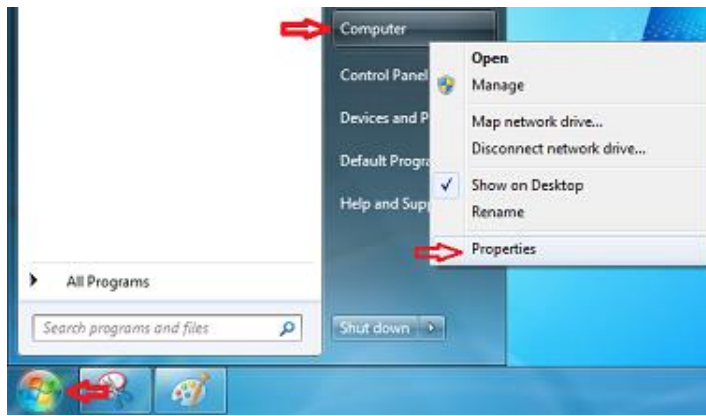

- b. Scroll down and locate Computer name, domain, and workgroup settings. Click Change Settings

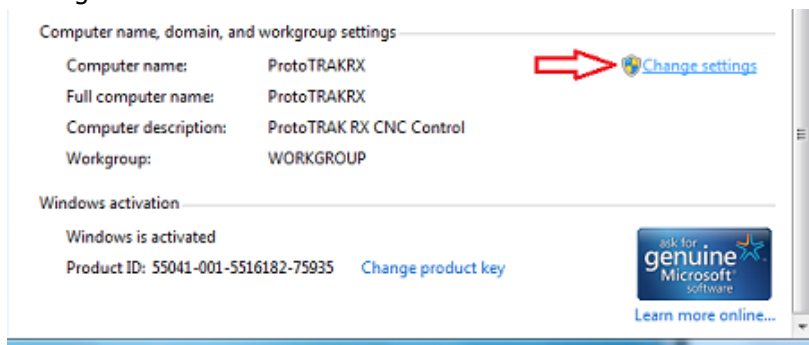

- c. On the Computer Name tab, click Change

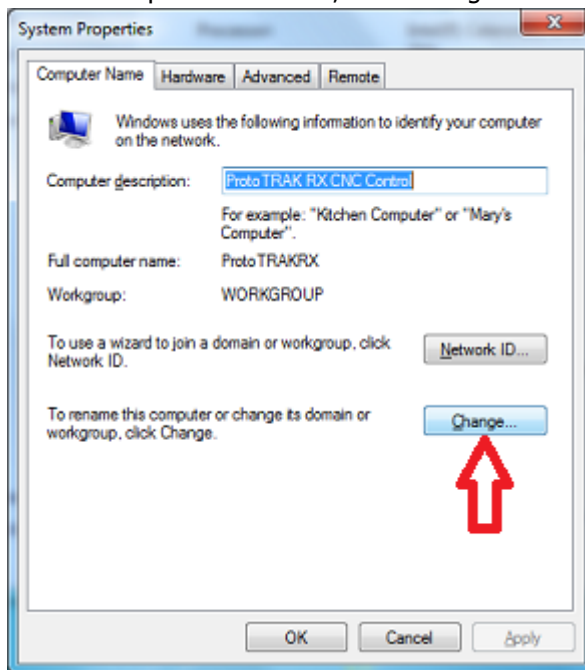

- d. Write down the Workgroup name. If you prefer you, you can change the workgroup name here and press OK to change the workgroup name. Write down the name change and follow these same steps to change the workgroup name on the RX control to match the PC.

(Note: If you're networking multiple RX Controls, you may need to change the computer name for each one to a unique name. You can change that here as well while changing the Workgroup name)

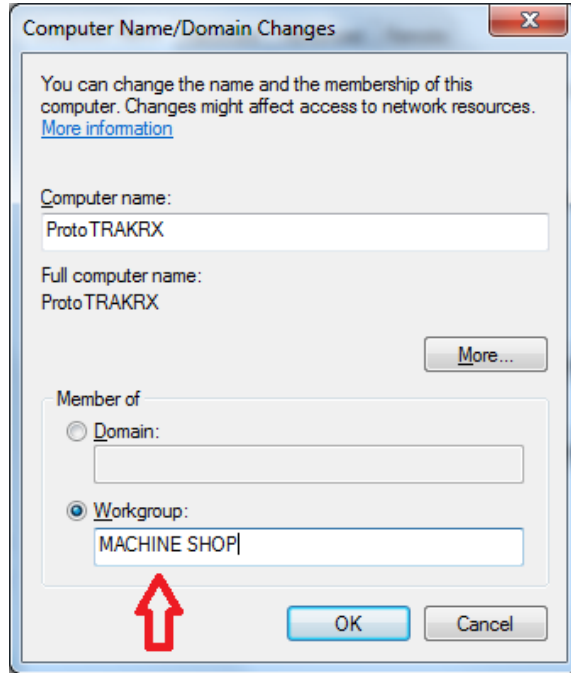

2. **(Optional)** - Secure Network Setup. In order to do a secure network setup requiring a user name and password login, you'll need to create a user account on your PC that can be utilized on the RX control for secure access to a shared folder on your computer. You may also use an existing user account on the PC but it *must* have a password associated with it. To create a user account, do the following:

- a. On your PC, click Start and then click Control Panel

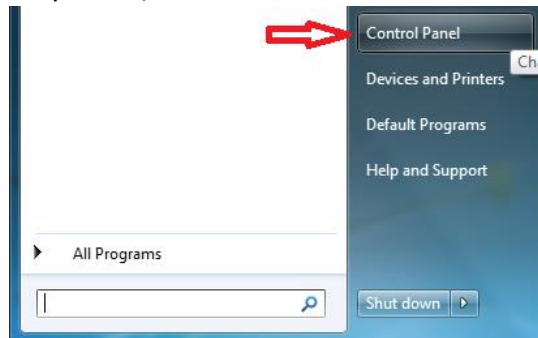

- b. Under User Accounts, click Add or remove user accounts



c. Click Create a new account

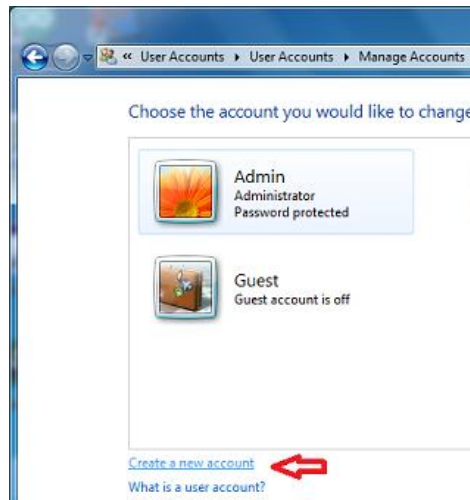

d. Input the user account name and select the user account type (Standard or Administrator) and click Create Account.

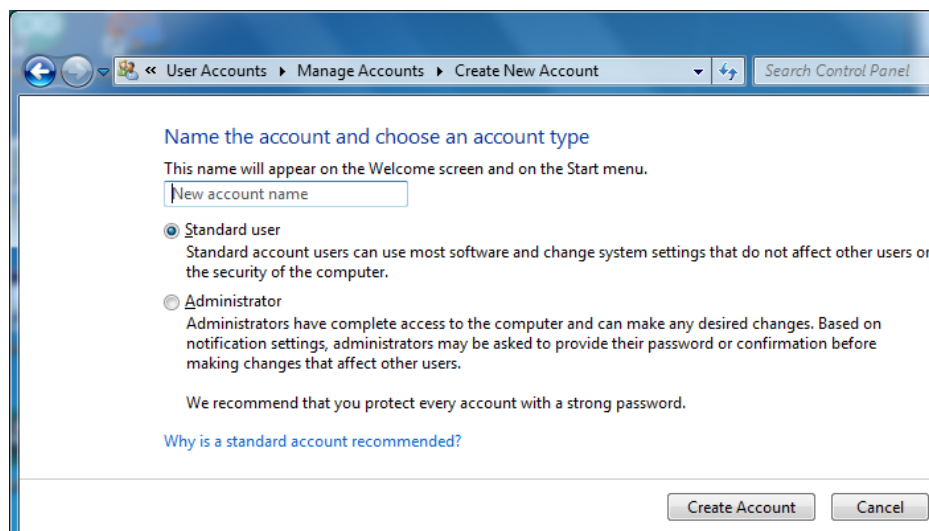

e. Once the account is created, click on the account you've created



f. Click Create a password



g. Create a strong password that you can easily remember and input a hint as to what your password would be to remind you in case you forget, then click Create Password.



3. Networking the RX control to the PC – With the workgroup names now changed and securely networking the control, the User account is created, the following are the instruction for creating a mapped network drive and for the control access in order to network the RX control to your PC. Make sure your PC and RX control are connected to the router. If the router has any special requirements, see the instructions for setting up your router or contact the router manufacturer beforehand. If you have any other special network requirements, see your IT Administrator or call into Customer Service 800-367-3165 with any questions for support. There are some common instructions between them so make sure you're following the instruction based on your operating system accordingly.

From the PC: (If you plan to use secure access, have a user account created on the PC for login permission. Make sure the Workgroup name on both PC and RMX are the same)

- a. Press the Windows Start button on your keyboard and click Control Panel

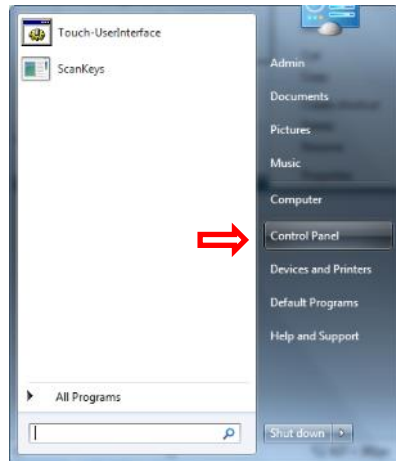

- b. Click Network and Internet

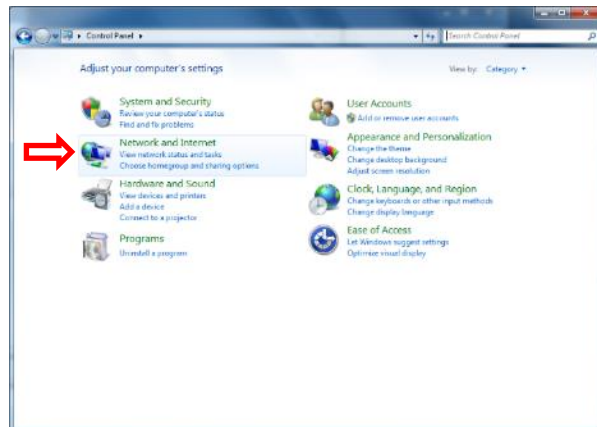

- c. Click Network and Sharing Centre, then Change advanced sharing settings

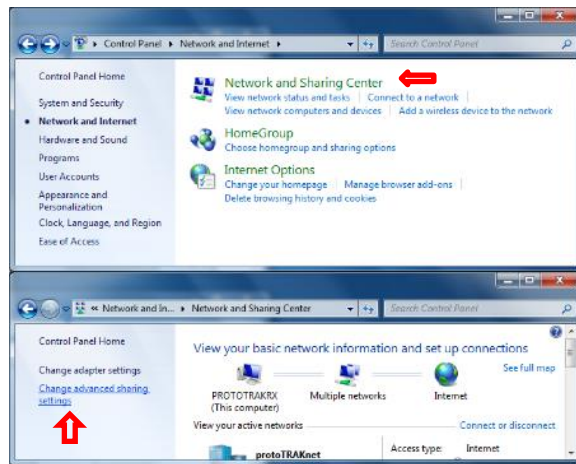

d. Expand Guest or Public, Turn on file and printer sharing, then expand All Networks

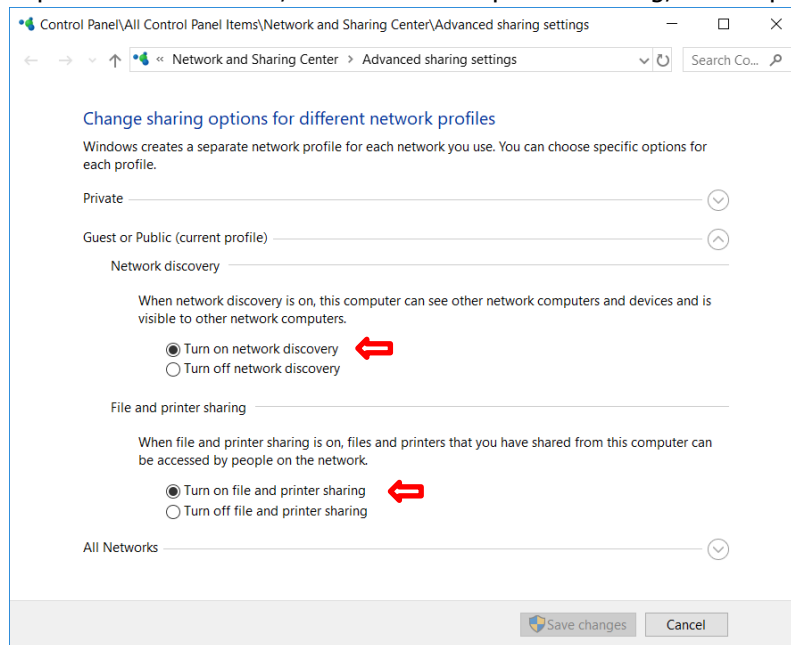

e. Under All Networks, scroll down and Turn off password protected sharing (Turn on if you plan to log in with a user account. You must use the login of the user account from the PC.)

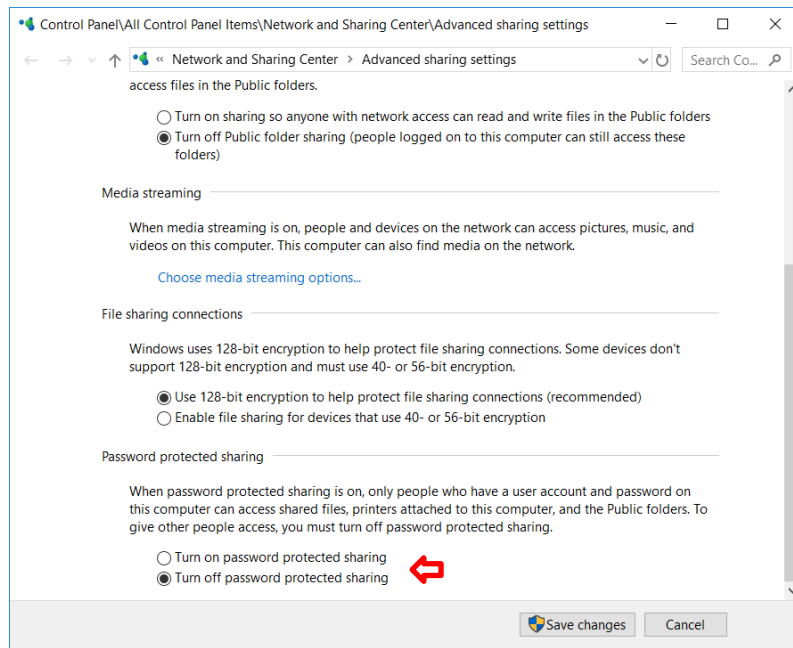

f. Create a shared folder in desired location on the PC

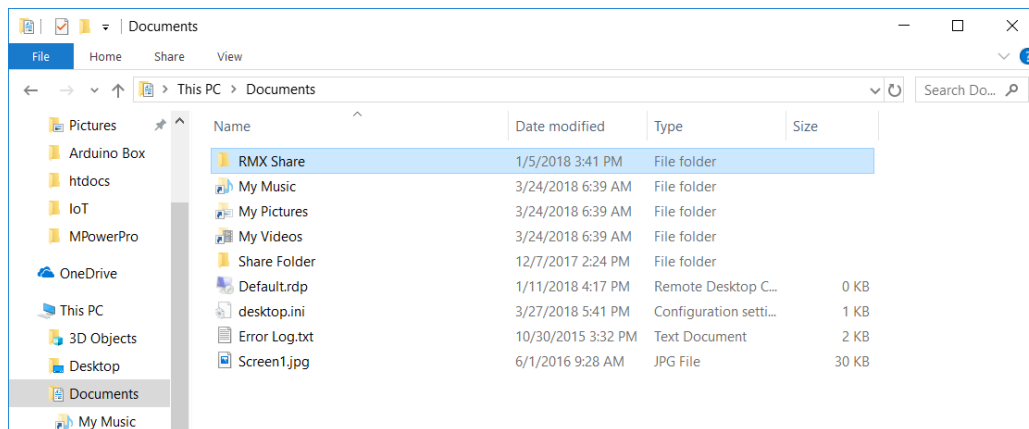

g. Right Click and move your mouse to Share with, click Specific people

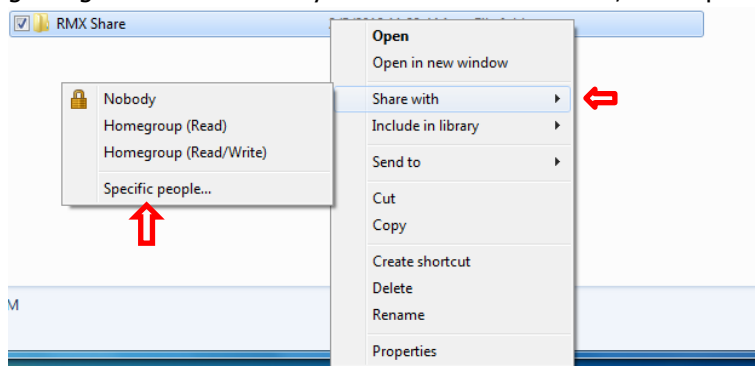

h. Select the drop down and click Everyone

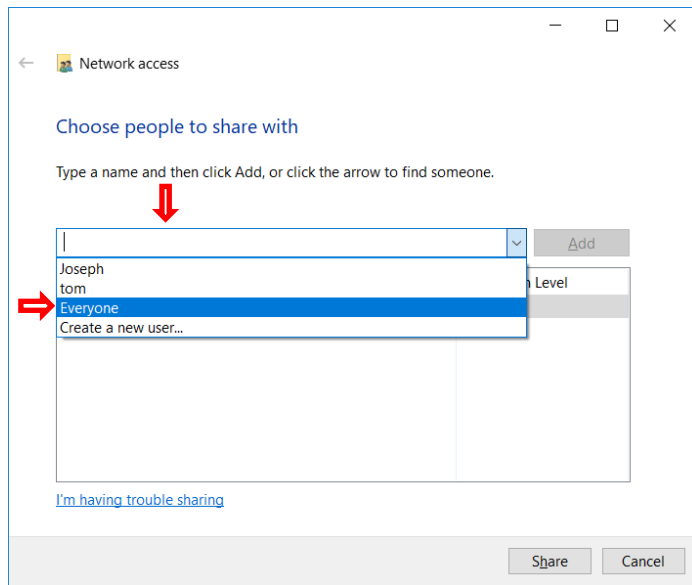

- i. Change Permission Level to Read/Write, then click Share

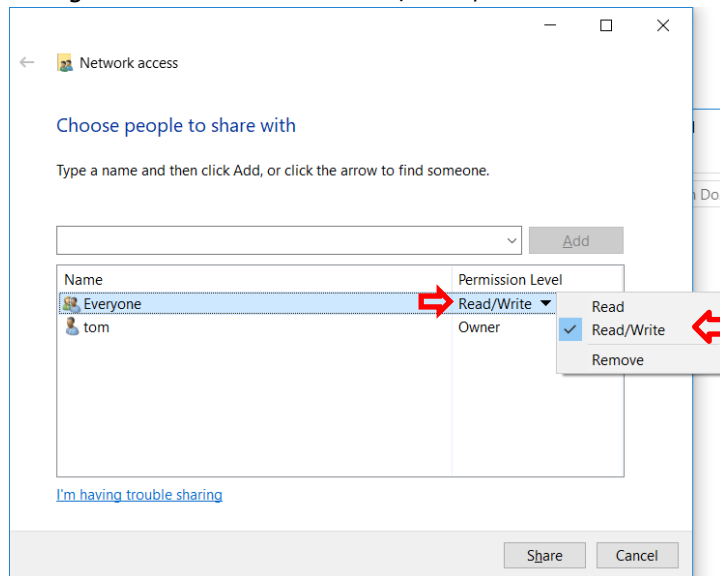

- j. On the RMX, press the Windows Start key and click My Computer

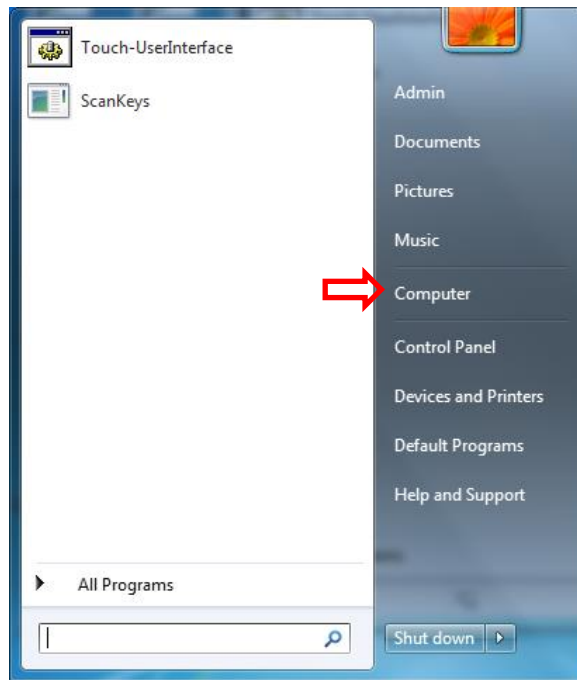

k. Click on Map Network Drive

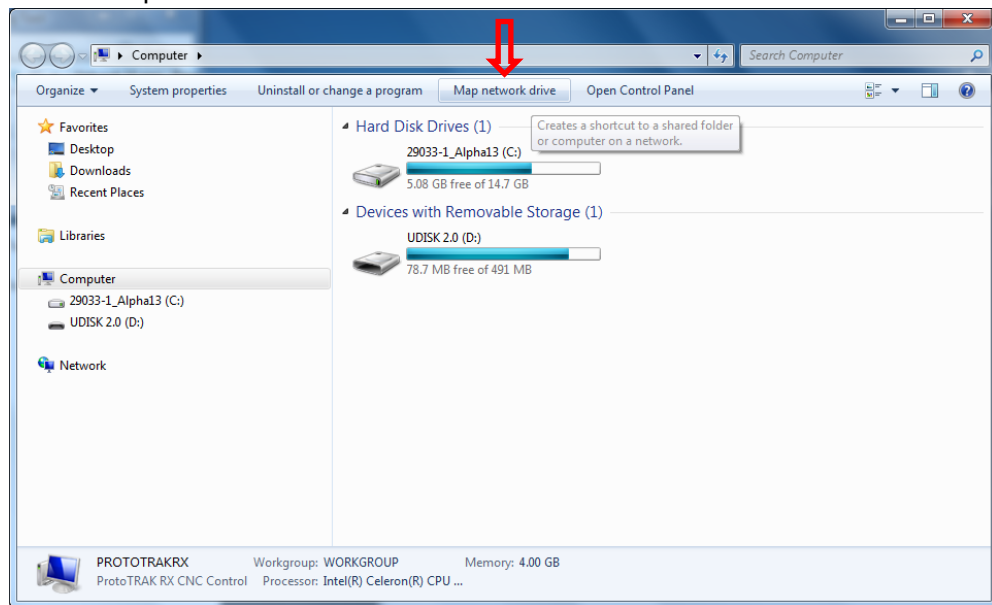

l. Click the Drive drop down menu and select a drive letter. Click Browse

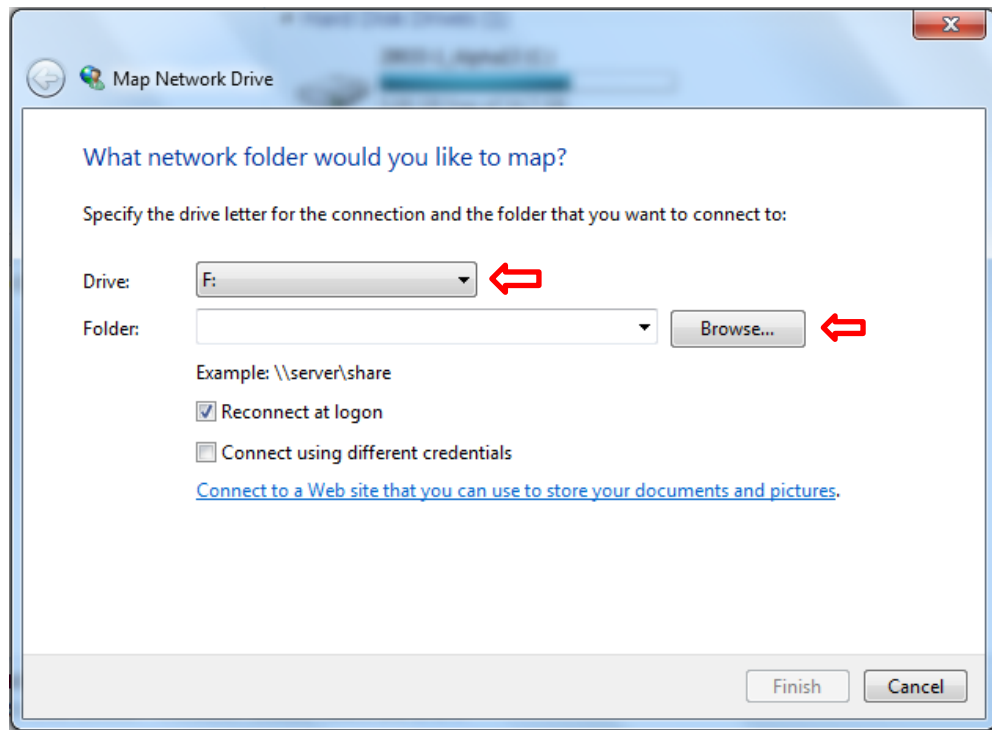

- m. Navigate to the computer your shared folder is on. If you have Password protected sharing on, you'll be required to input your user name and password from User Account you created on your PC (skip this if you have Password protected off). Make sure Remember my credentials is checked.

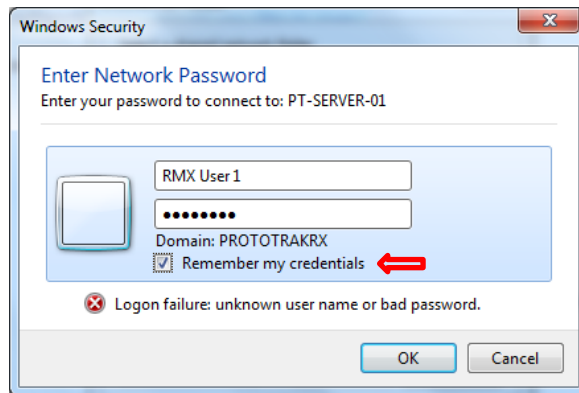

- n. Navigate to and select the shared folder from the PC you're mapping to and click OK

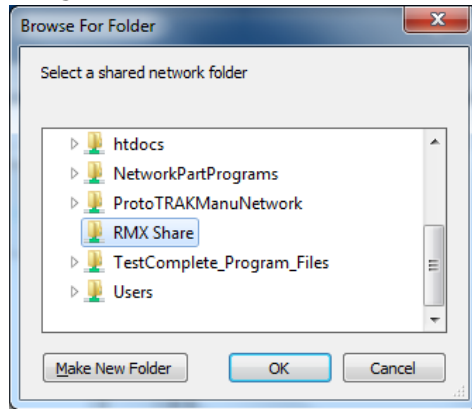

- o. Click Reconnect at logon then click Finish

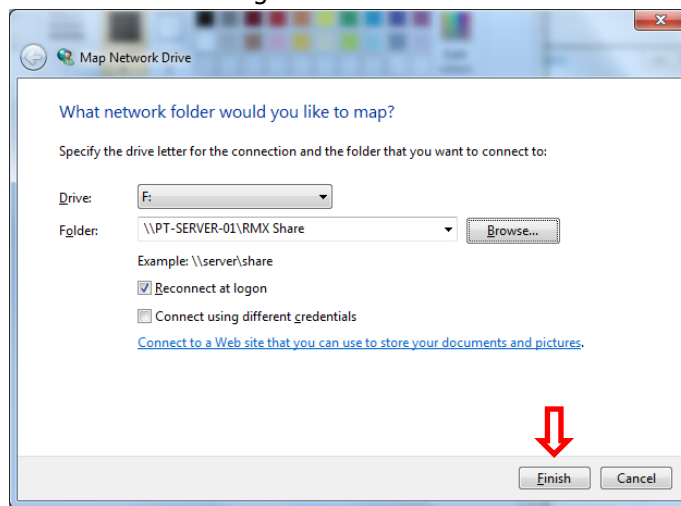

14.14.2 Networking – Windows 10

Networking Requirements:

- Setting up the RMX/RLX on a Workgroup for Windows 10
- Straight thru CAT 5 / Ethernet Cable
- Mouse & Keyboard plugged into the RX controller
- Local Admin rights to the PC
- Obtain a DSL Cable router with DHCP Services
- All clicking on the mouse will be done with left button (left click) unless specified to right click

Basic Peer to Peer Network Utilizing Workgroup

1. In order to establish a Workgroup Network in Windows 10, the computer and control must have the same workgroup name in order to be able to communicate with each other. You'll need to check the Workgroup name on your PC and if you wish to, modify the name as well and then adjust it on the RX side to match in order to be able to network the two together. To do this, perform the following steps:
 - a. On the PC, Click on the Cortana Search bar and type in Workgroup, then click Change Workgroup Name.

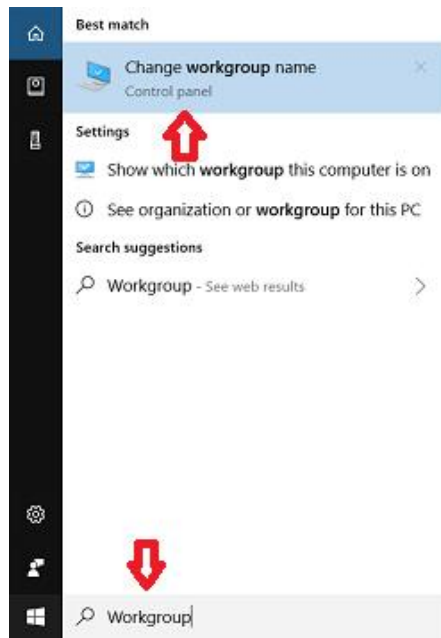

b. In the area highlighted, you can view the Workgroup names.

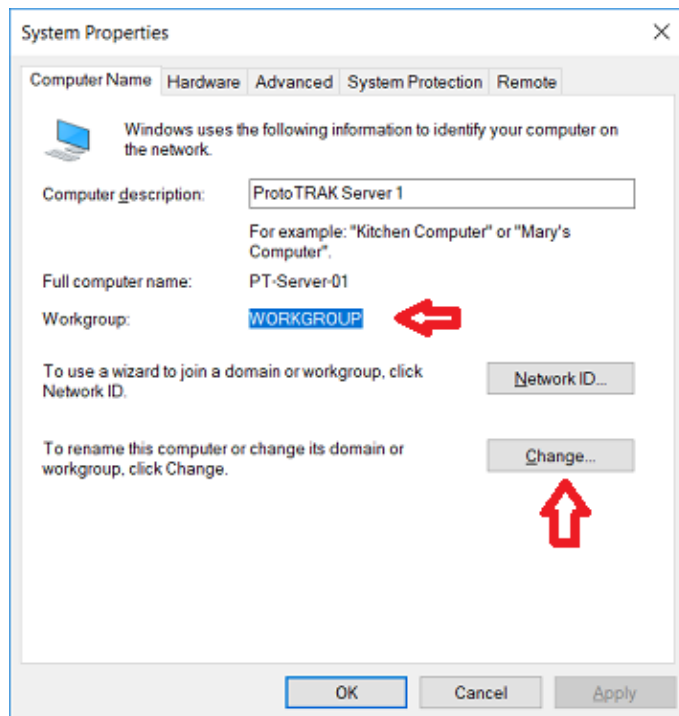

c. If you wish to change it, click Change. Under Workgroup, change the workgroup name in the text box and click OK

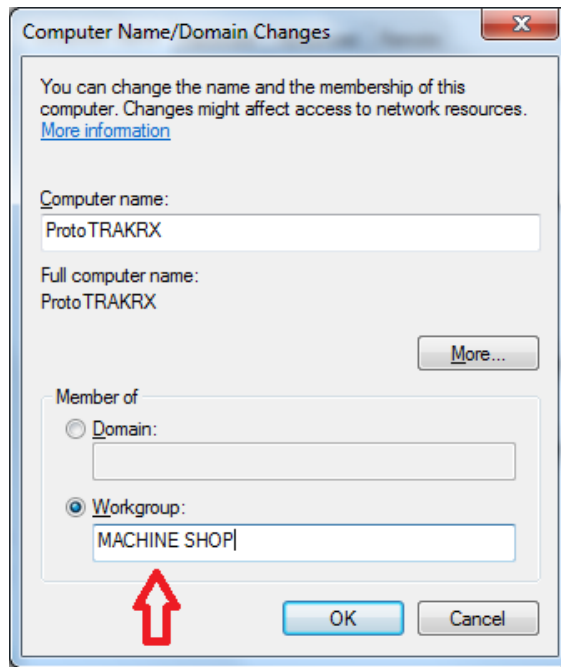

d. Follow steps 1-4 in the previous section 1.2.1 on the RX control to change the Workgroup name to match the Windows 10 workgroup name.

2. **(Optional)** - Secure Network Setup. In order to do a secure network setup requiring a user name and password login, you'll need to create a user account on your PC that can be utilized on the RX control for secure access to a shared folder on your computer. You may also use an existing user account on the PC but it **must** have a password associated with it. To create a user account, do the following:

a. Click in the Cortana Search Bar and type in: User Accounts, then click Add, Edit, or Remove other people

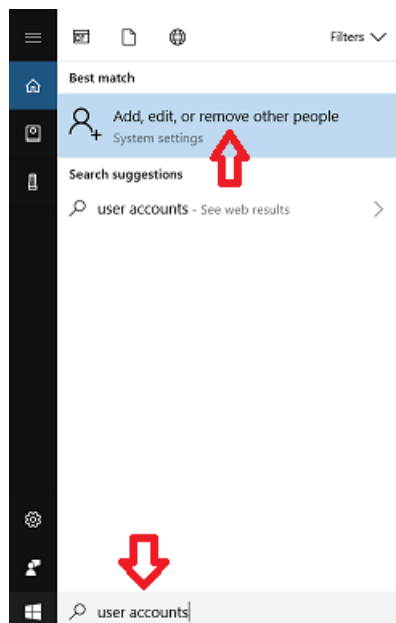

- b. Click Add someone else to this PC

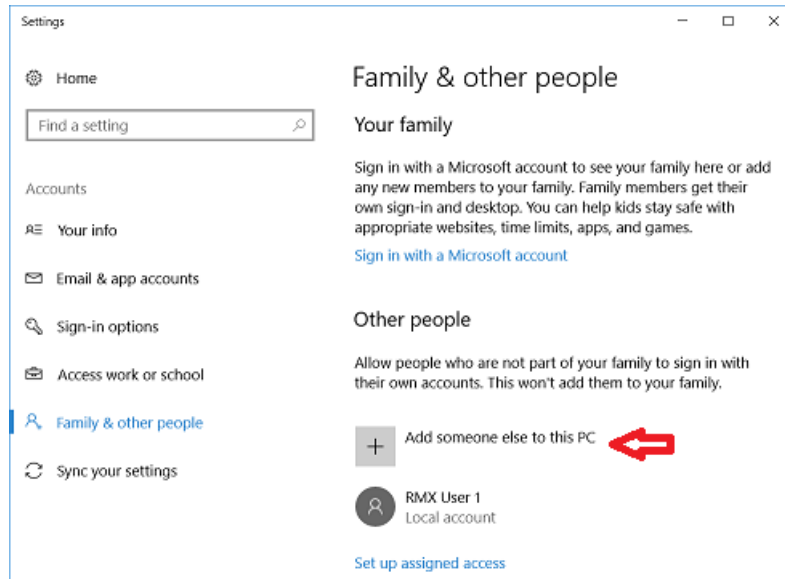

- c. Then type in a desired user name, a strong password that you can remember, and a password hint that will remind you of what that password is in case the password is forgotten and click Next.

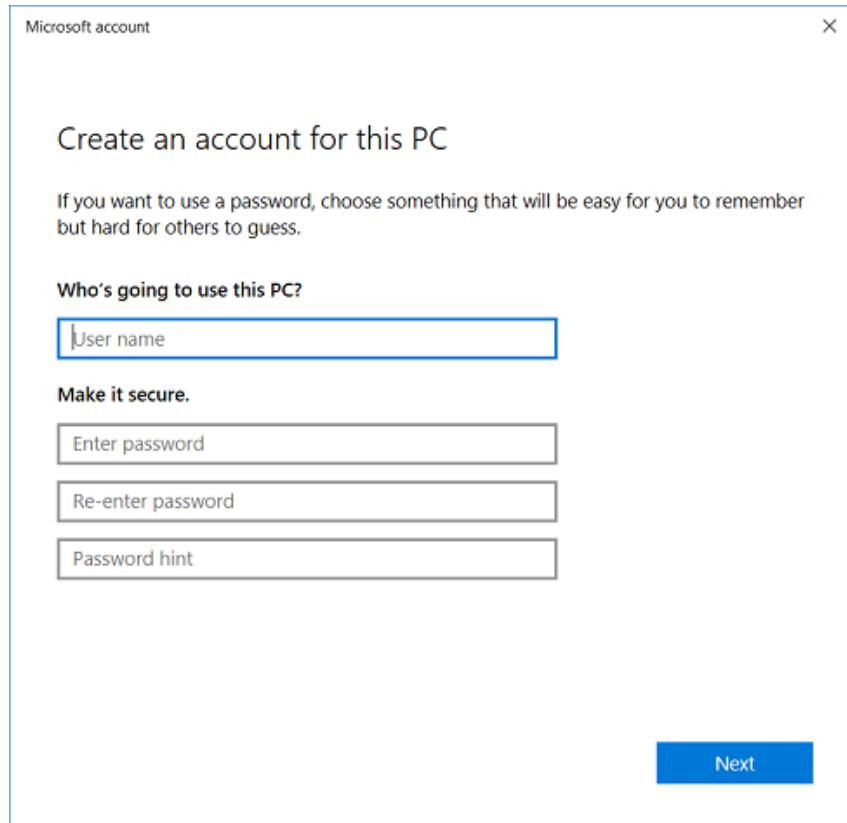

3. Networking the RX control to the PC – With the workgroup names now changed and securely networking the control, the User account is created, the following are the instruction for creating a mapped network drive and for the control access in order to network the RX control to your PC. Make sure your PC and RX control are connected to the router. If the router has any special requirements, see the instructions for setting up your router or contact the router manufacturer beforehand. If you have any other special network requirements, see your IT Administrator or call into Customer Service 01823 674200 with any questions for support. There are some common instructions between them so make sure you're following the instruction based on your operating system accordingly.

From the PC: (If you plan to use secure access, have a user account created on the PC for login permission. Make sure the Workgroup name on both PC and RMX are the same)

- a. Press the Windows Start button on your keyboard and go to Settings

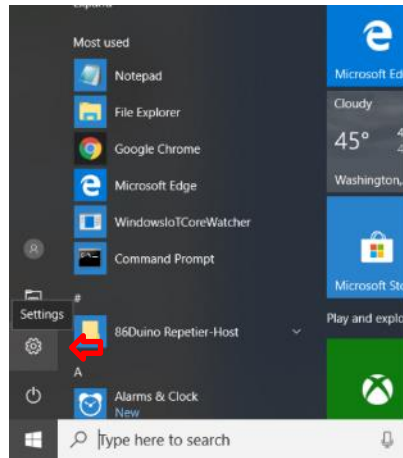

- b. Click Network and Internet

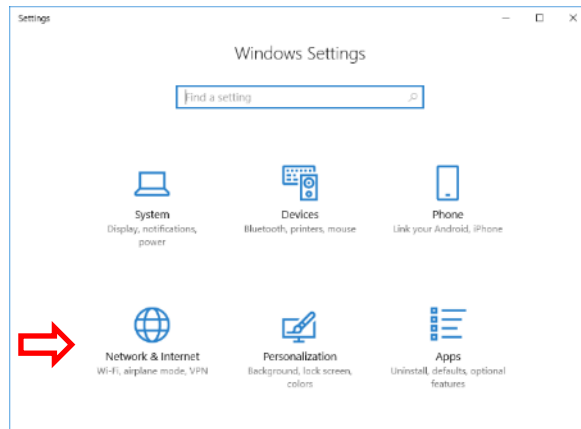

- c. Click Sharing options

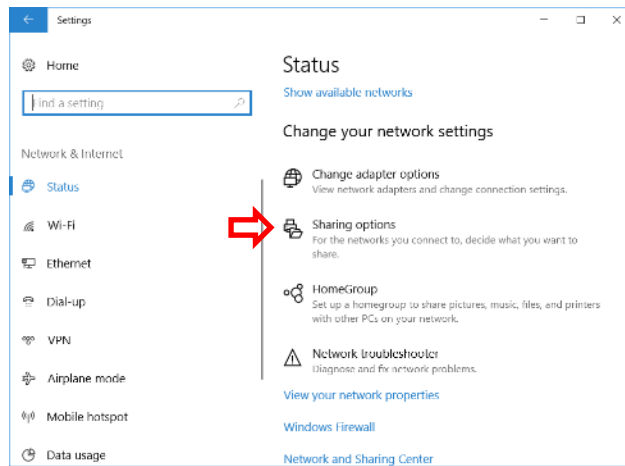

- d. Expand Guest or Public, Turn on file and printer sharing, then expand All Networks

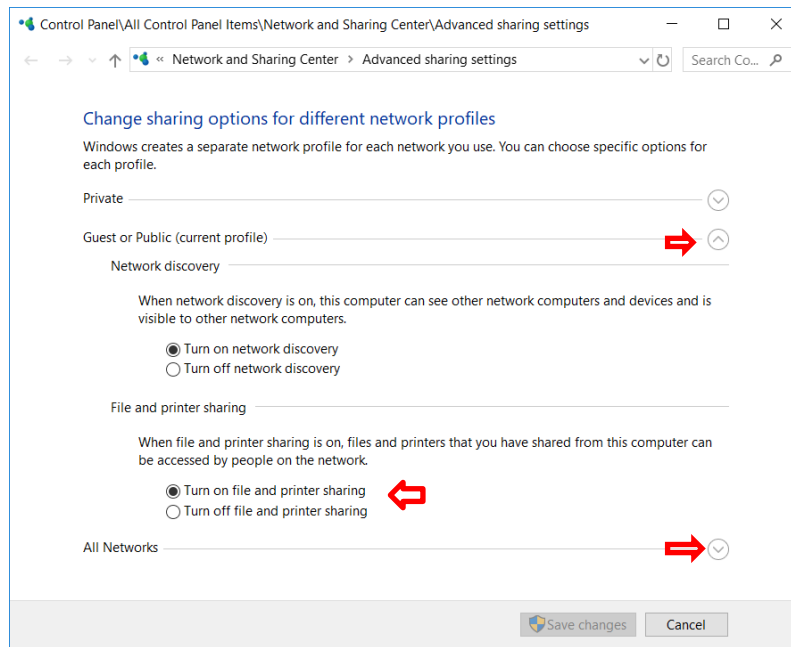

- e. Under All Networks, scroll down and Turn off password protected sharing (Turn on if you plan to log in with a user account. You must use the login of the user account from the PC.)

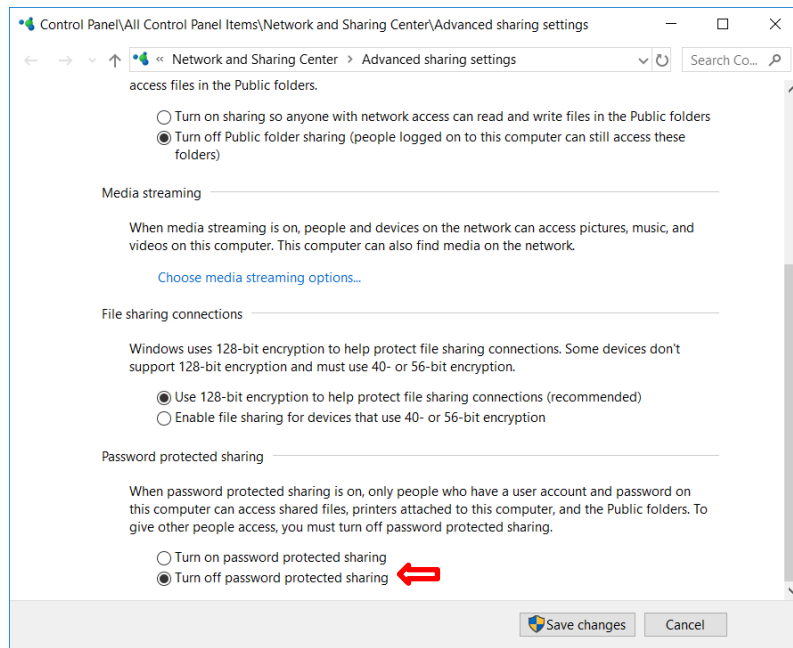

f. Create a shared folder in desired location on the PC

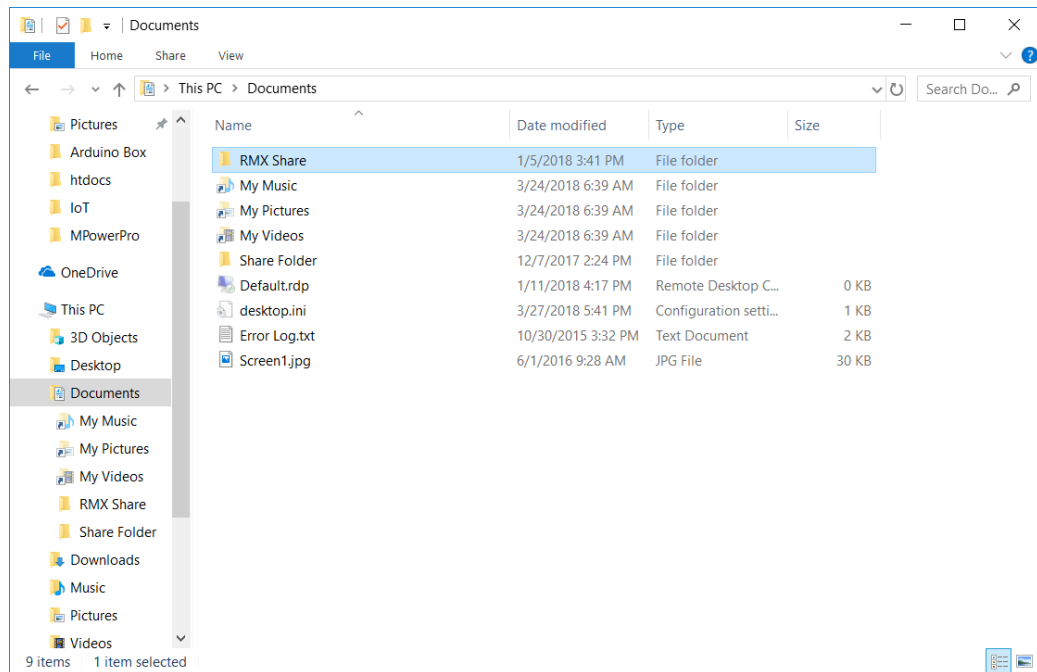

g. Right click and move your mouse to Give access to, then click Specific People

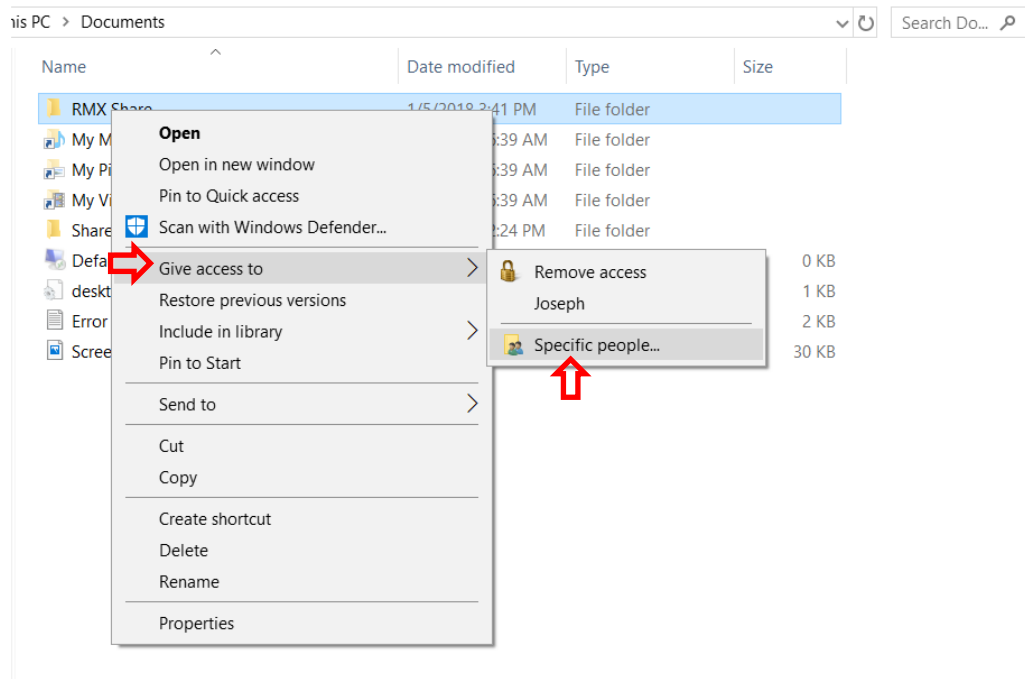

h. Select the drop down and click Everyone

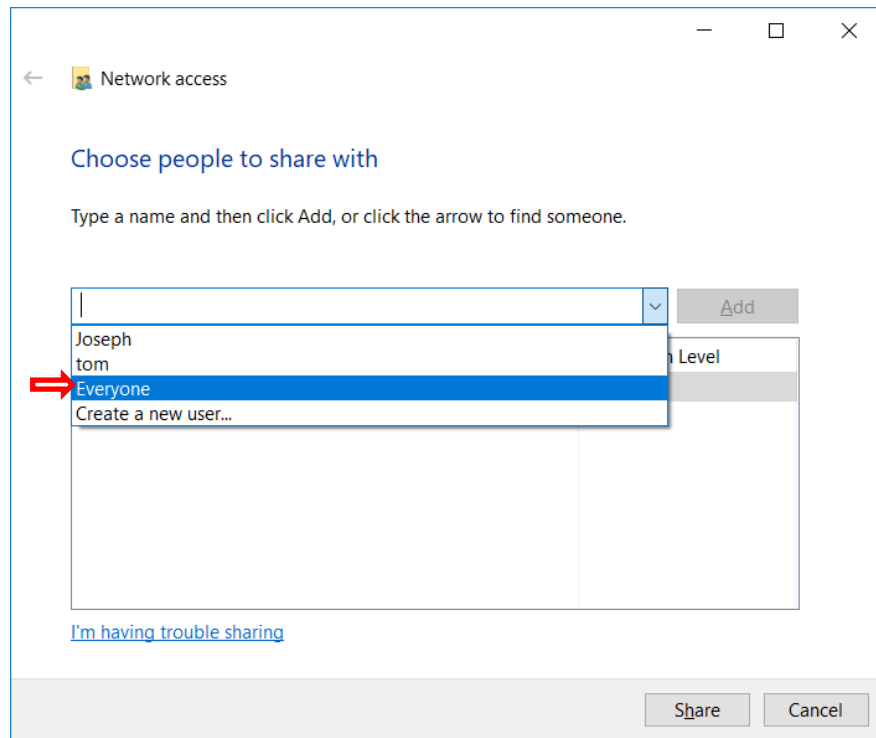

i. Change Permission Level to Read/Write, then click Share

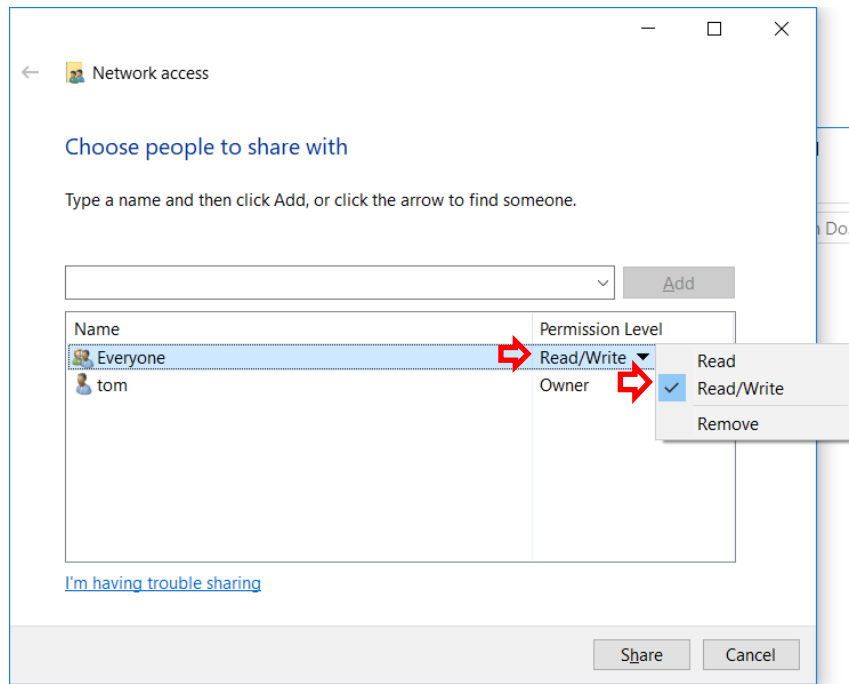

- j. On the RMX, press the Windows Start key and click My Computer

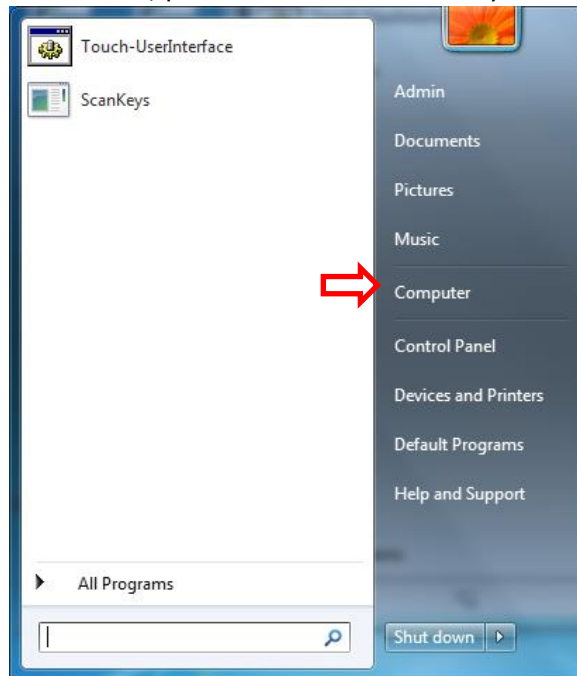

- k. Click on Map Network Drive

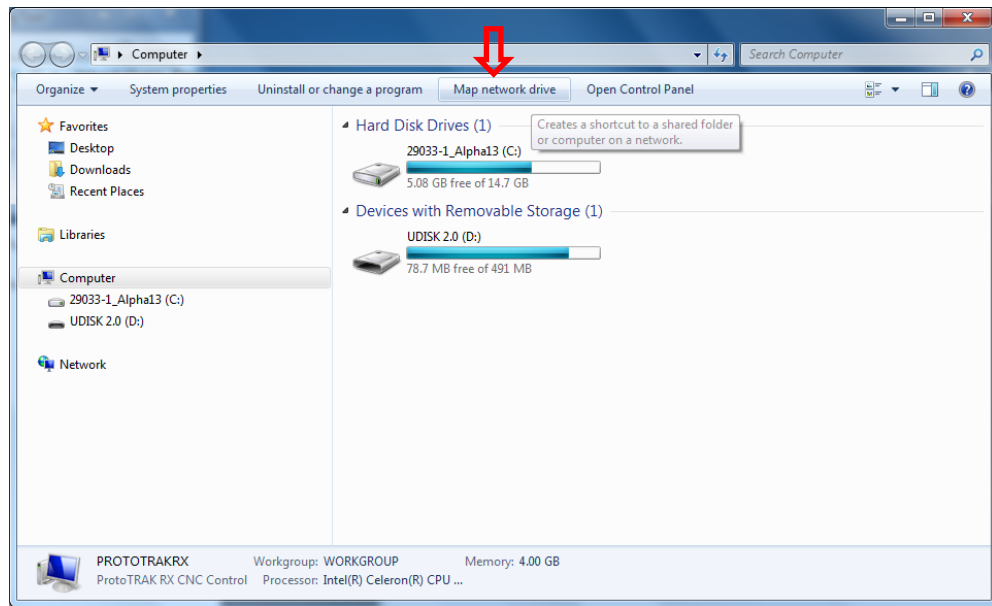

- i. Click the Drive drop down menu and select a drive letter. Click Browse

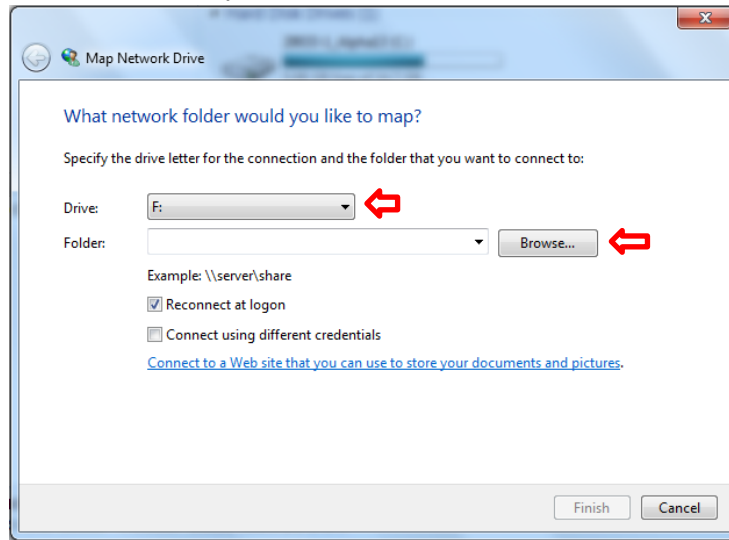

- m. Navigate to the computer your shared folder is on. If you have Password protected sharing on, you'll be required to input your user name and password from User Account you created on your PC (skip this if you have Password protected off). Make sure Remember my credentials is checked.



- n. Navigate to and select the shared folder from the PC you're mapping to and click OK

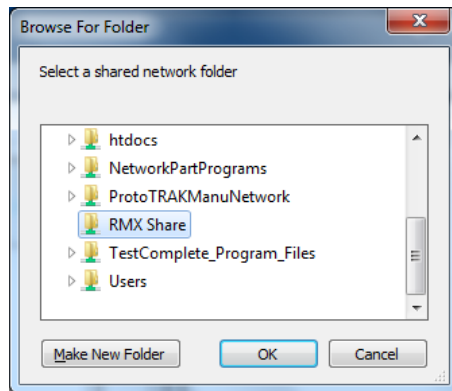

- o. Click Reconnect at logon then click Finish

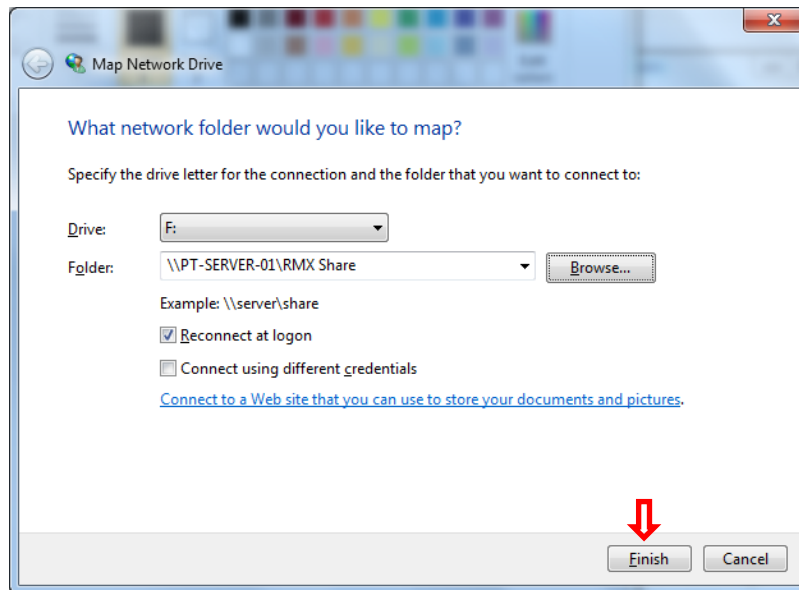

XYZ Machine Tools Ltd.

ProtoTRAK UK Warranty Policy

Warranty

ProtoTRAK products are warranted to the original purchaser to be free from defects in workmanship and materials for the following periods:

Product	Warranty Period
New ProtoTRAK Controlled Machine	12 Months
Any Exchange Unit or Spare Part	6 Months

The warranty period starts on the date of the invoice to the original purchaser from XYZ Machine Tools Ltd (XYZ) or their authorised distributor. If a unit under warranty fails, it will be repaired or exchanged at our option for a properly functioning unit in similar or better condition. Such repairs or exchanges will be made carriage paid within the UK mainland.

Disclaimers of Warranties This warranty is expressly in lieu of any other warranties, express or implied, including any implied warranty of merchantability or fitness for a particular purpose, and of any other obligations or liability on the part of XYZ (or any producing entity, if different). Warranty repairs/exchanges do not cover incidental costs such as installation, labour, etc.

- XYZ is not responsible for consequential damages from use or misuse of any of its products.
- ProtoTRAK products are precision mechanical/electromechanical measurement systems and must be given the reasonable care that these types of instruments require.
- Replacement of slideway wipers and covers is the responsibility of the customer. Consequently, the warranty does not apply if swarf or coolant have been allowed to enter the mechanism.
- This machine is designed to cut common, metallic engineering materials (such as steel and aluminium). DO NOT use to cut special materials (such as composites or abrasives) without agreement from XYZ Machine Tools. Any damage caused to the machine by processing such materials will not be covered by the warranty.
- Accidental damage, beyond the control of XYZ, is not covered by the warranty. Thus, the warranty does not apply if an instrument has been abused, dropped, hit, disassembled or opened.
- Improper installation by or at the direction of the customer in such a way that the product consequently fails, is considered to be beyond the control of the manufacturer and outside the scope of the warranty.